

FREE COPY

The Solar Energy Workbook has been written for you to learn the basics of solar energy and to be aware of its benefits to save our earth from pollutions. This FREE copy of the workbook can be colored and sent back as a PDF copy when completed. We will review it and reward you with an International Certificate from the USA as appreciation of your dedication and efforts.



**Schools
Support
Available**

www.solarenergyworkbook.com



ISBN: 978-99901-32-50-2
2019/278

American Solar Energy Society

2525 Arapahoe Avenue
Suite E4-253
Boulder, CO 80302
Website: www.ases.org

Copyright ©2020

FREE COPY

SOLAR ENERGY WORKBOOK

MY PERSONAL COPY

Full Name	
Age	
Contact Phone	
Email Address	
Date	

Special thanks to our member Yousif Amin for creating the workbook idea and to Carly Rixham, Executive Director for producing it.

www.solarenergyworkbook.com



ISBN: 978-99901-32-50-2
2019/278

American Solar Energy Society

2525 Arapahoe Avenue

Suite E4-253

Boulder, CO 80302

Website: www.ases.org

Copyright ©2020

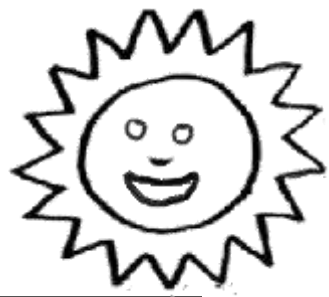

CONTENT

<i>Subject</i>	<i>Page</i>
Introduction	1
Solar System	2
Renewable Energy	3
Stop Pollution	4
Love Nature	5
Wind Energy	6
Bio Energy	7
Water Energy	8
Solar Energy	9
Photovoltaic (PV)	10
Voltage Types	11
Solar Cells	12
Front Panel	13
Back Panel	14
Panel Construction Layers	15
Solar Energy System	16
Battery, Control & Inverter	17
Financial Benefits	18
Net Metering	19
Solar Tracking	20
Auto Tracking System	21
Fixed Tilt Angle	22
Shades on Panels	23
Heat on Panels	24
Dirt on Panels	25
Power Consumption Guide	26
One (1) Watt Panel	27
Ten (10) Watts Panel	28
Hundred (100) Watts Panel	29
Solar Bus-Stop	30
Solar Tent	31
Worksheets 1-6	32-37
Worksheets Answers	Not Available
3D Solar House Project	with Free Copy



INTRODUCTION

This solar energy workbook will help you to learn more about the basics of solar energy. It will explain in a simple and enjoyable way how a tiny solar cell can generate electricity for use at our homes and schools. Also, how and why solar energy from the sun can benefit our environment for clean and less pollution for all mankind's survival on earth.

In addition, the financial benefits of the net metering concept will be explained. It is based on making use of the sun to supply our homes electricity and to give back that extra power we don't use to the utility grid.

The coloring activities will also help you to enhance self-expression and colors recognition. Have fun while learning!

SOLAR SYSTEM

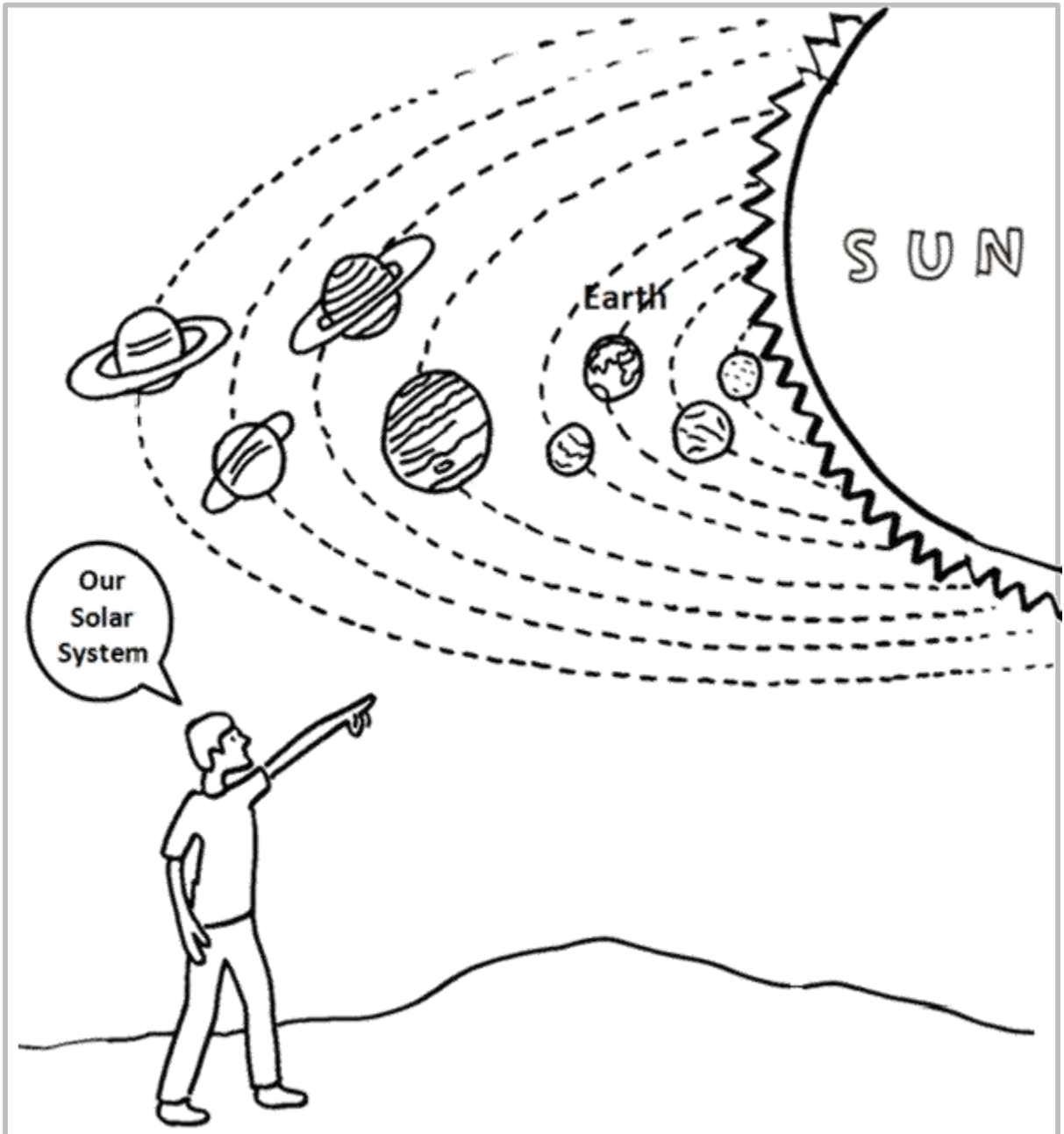

The sun is part of our solar system and provides FREE energy that we can use to power our lives.

RENEWABLE ENERGY

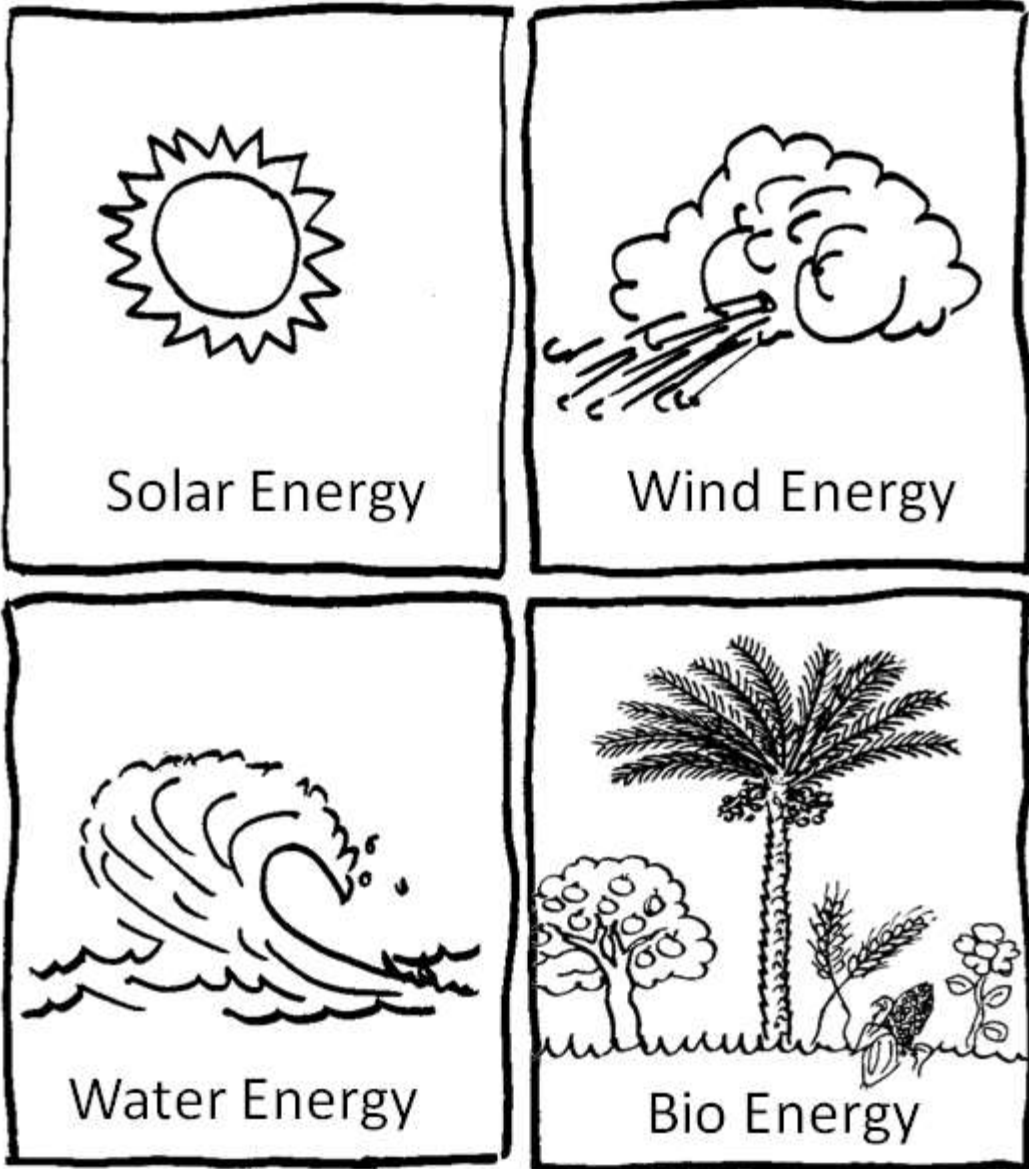

Renewable energy comes from renewable natural resources which are harmless to our environment, such as the sun, wind, rain, plants, geothermal heat, and sea tides.

STOP POLLUTION

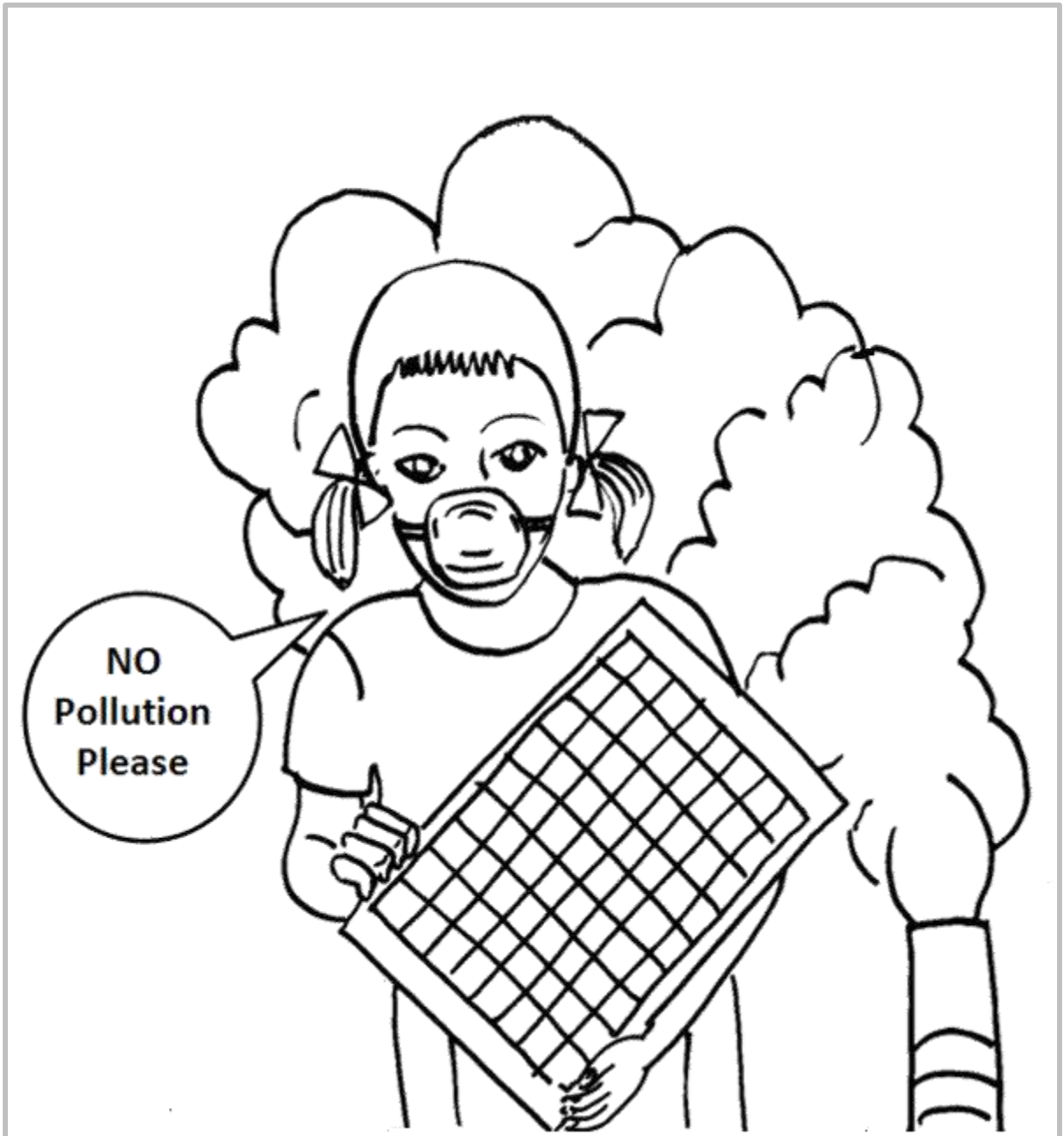

To stop pollution we need “clean energy” or “green energy” which is simply any form of renewable energy created with clean, harmless, and non-polluting methods, like solar and wind energy.

LOVE NATURE



Solar energy from the sun never runs out. It is clean, environment-friendly, and can help to keep nature alive and healthy with just small amounts of power.

WIND ENERGY

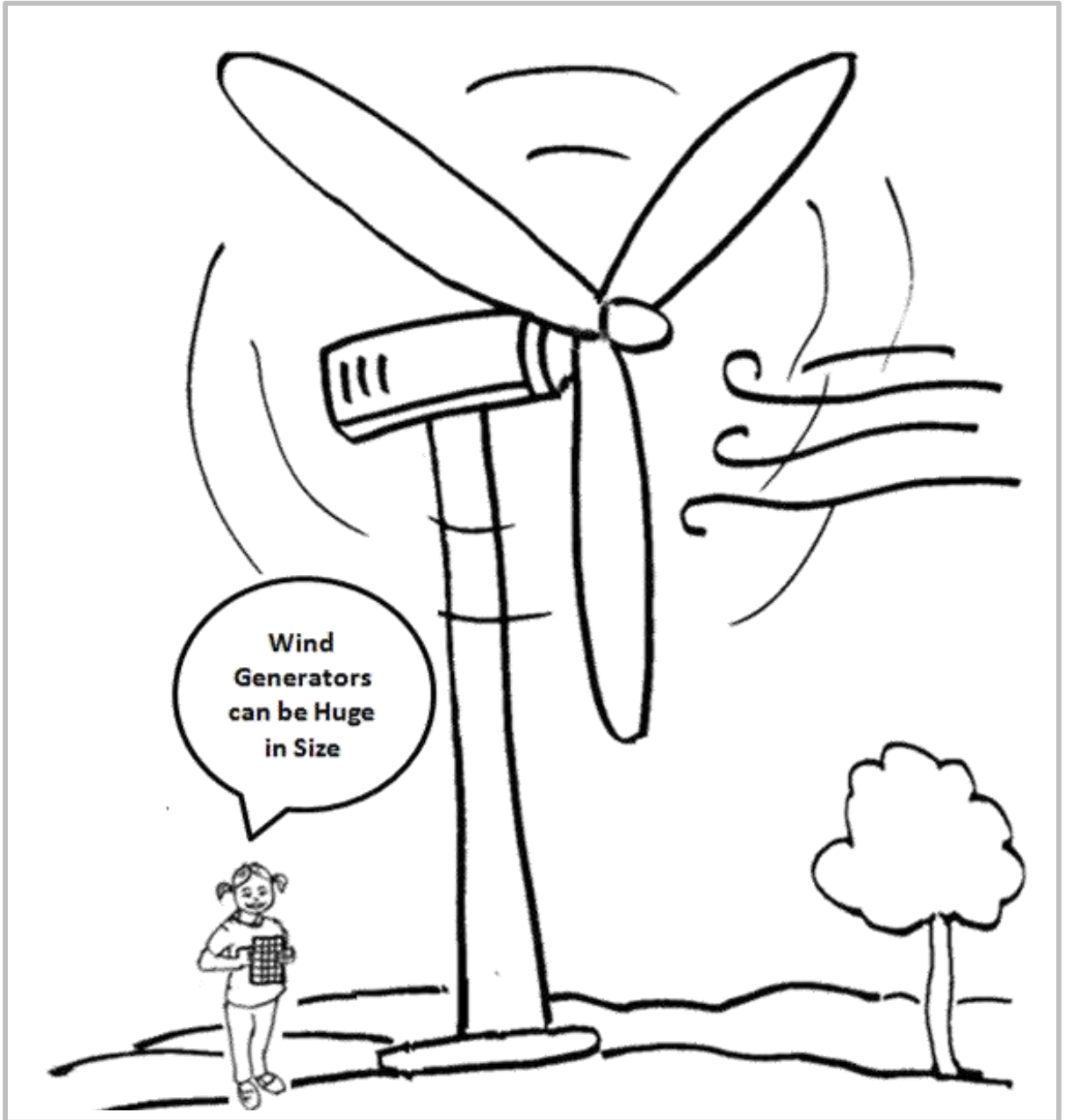

The wind energy is a clean energy. The strong wind turns the large blades very fast to generate electricity by the large turbine motors connected to them. However, they need more space and maintenance when compared to solar panels.

BIO ENERGY

Bio comes from the ancient Greek *bios*, which is “life”

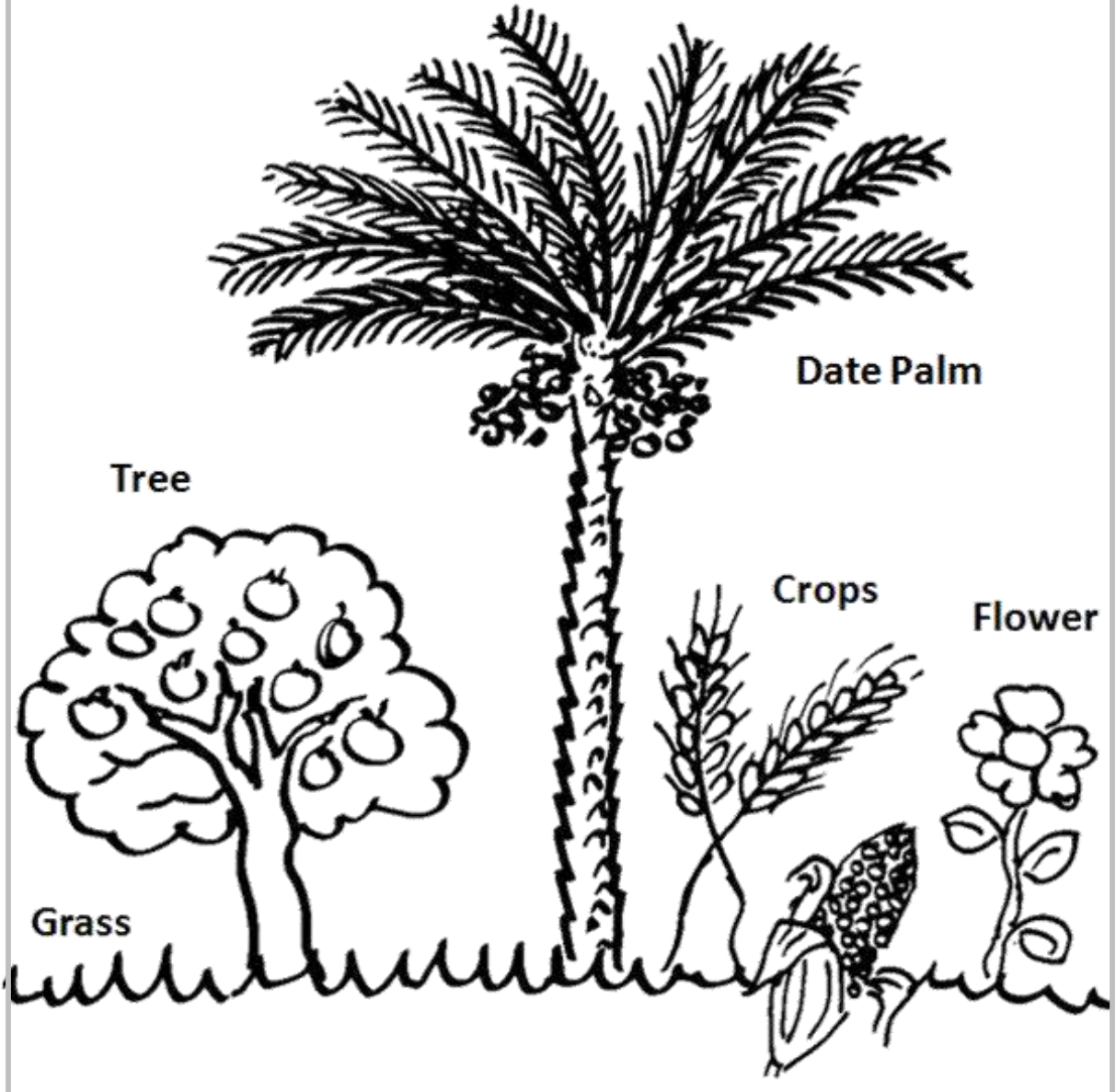

Bio-energy can be also used for electricity, heating, cooling and transport. It can be used as liquid form such as bio-fuel, or as gas like bio-gas, or as solid form, as is the case when burning wood.

WATER ENERGY

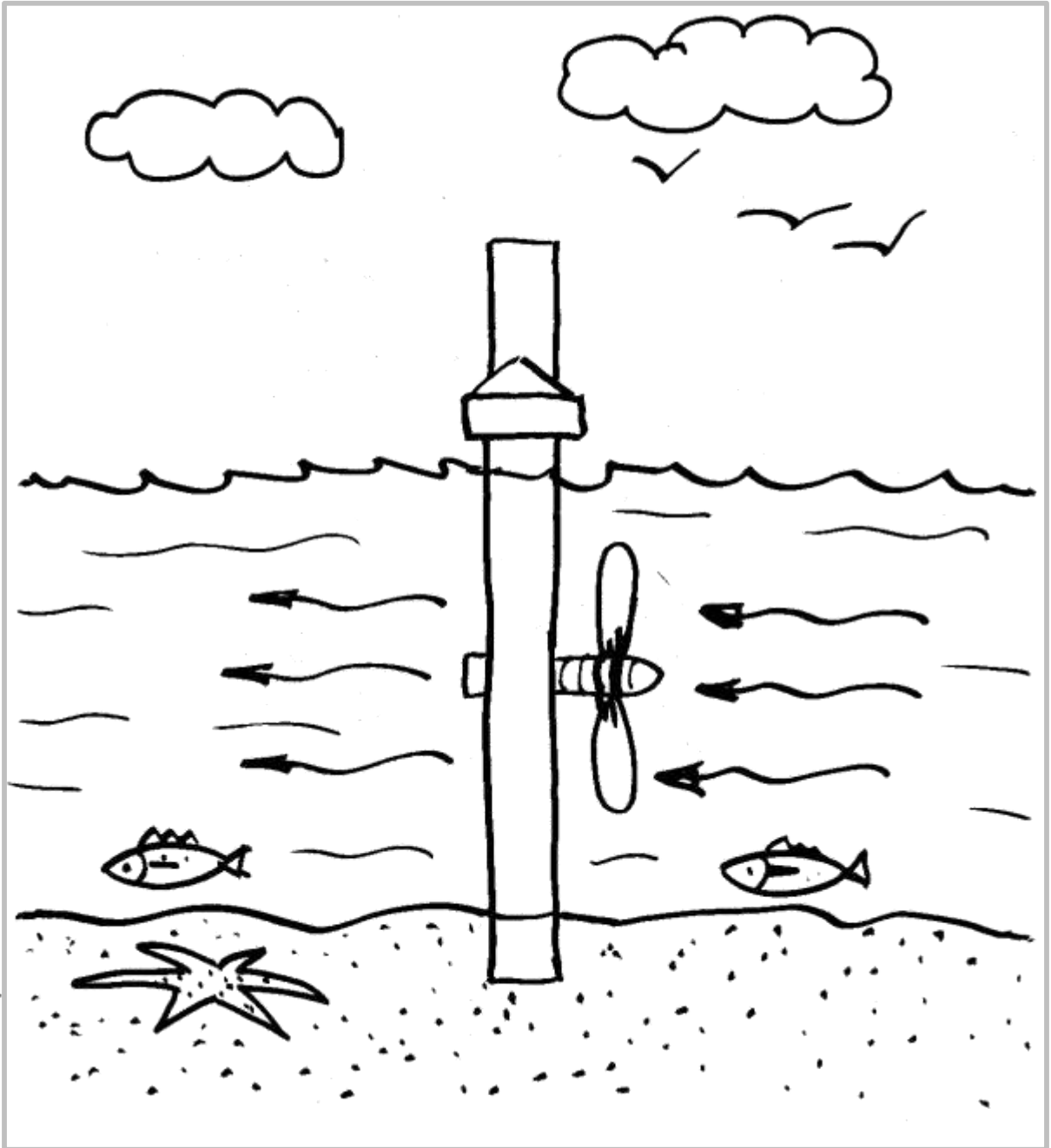

Water energy comes from rivers, seas and rains. In this example, the tidal energy is very similar to wind energy but instead of the air, we have tide driven water rotating the turbines.

SOLAR ENERGY

Solar comes from Late Middle English *solar*, from Latin *sōlāris*, from *sōl* ("sun")

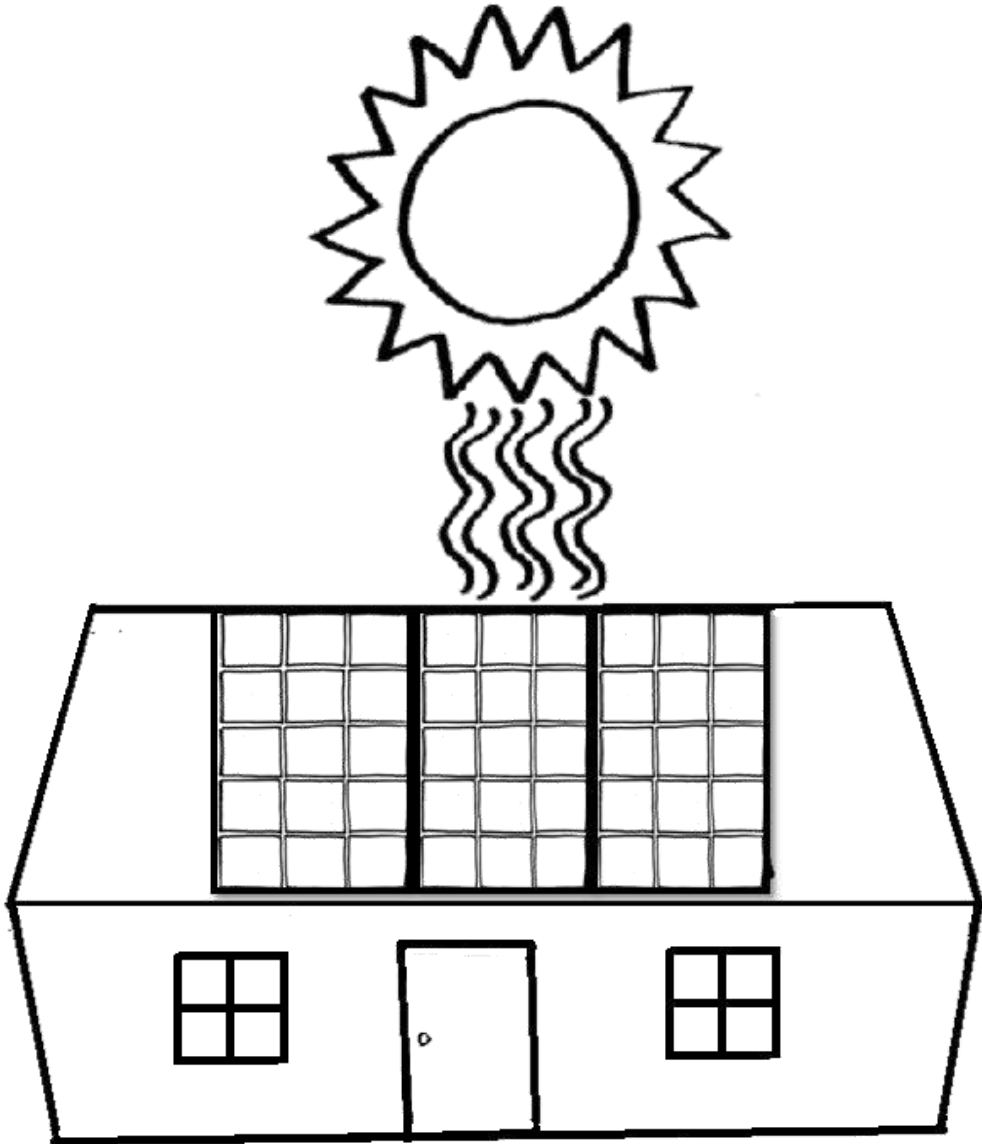

The sun is a free source of energy all year round. Its radiation reaches the solar panels on rooftops which converts energy into electricity to operate the household devices.

PHOTOVOLTAIC (PV)

(photo = light & voltaic = electrical potential)

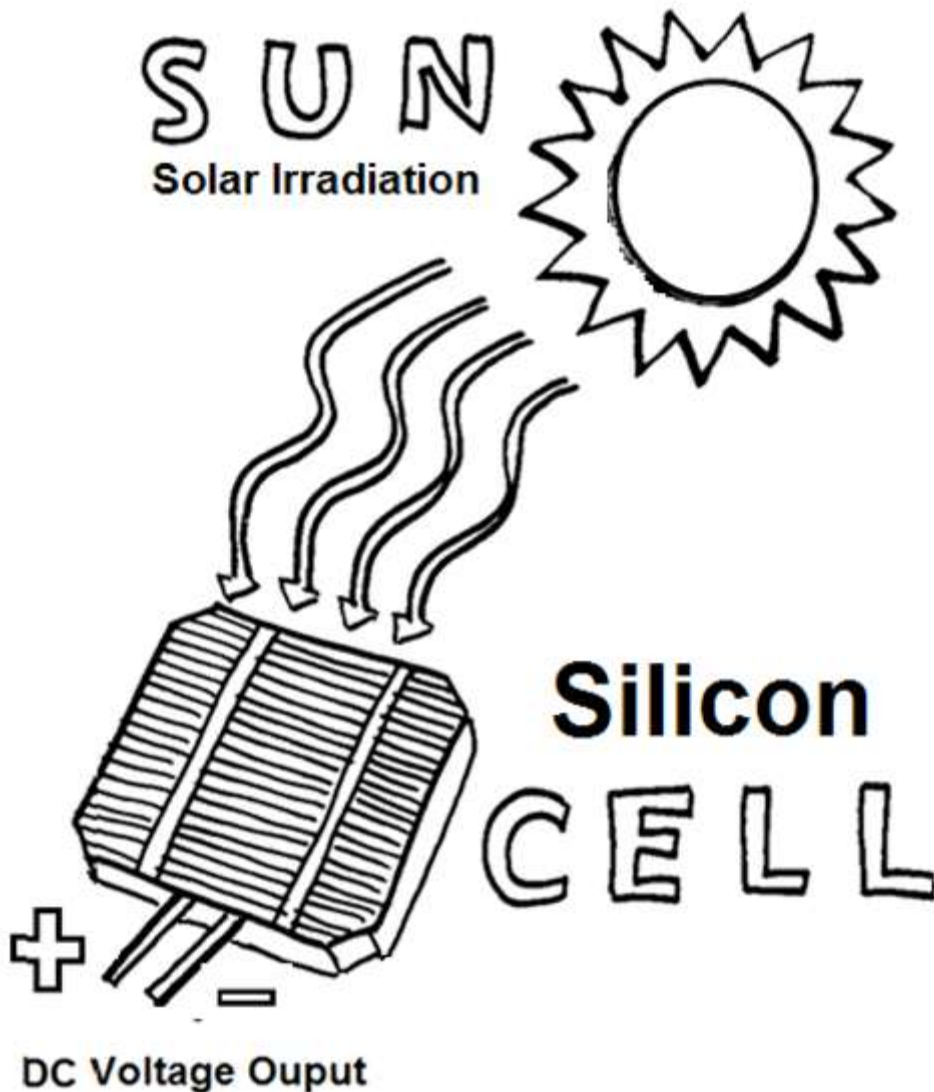

When the sun delivers energy to the earth by means of electromagnetic radiation, this Photovoltaic (PV) effect is the process by which several PV cells made from silicon converts sunlight into electricity.

VOLTAGE TYPES

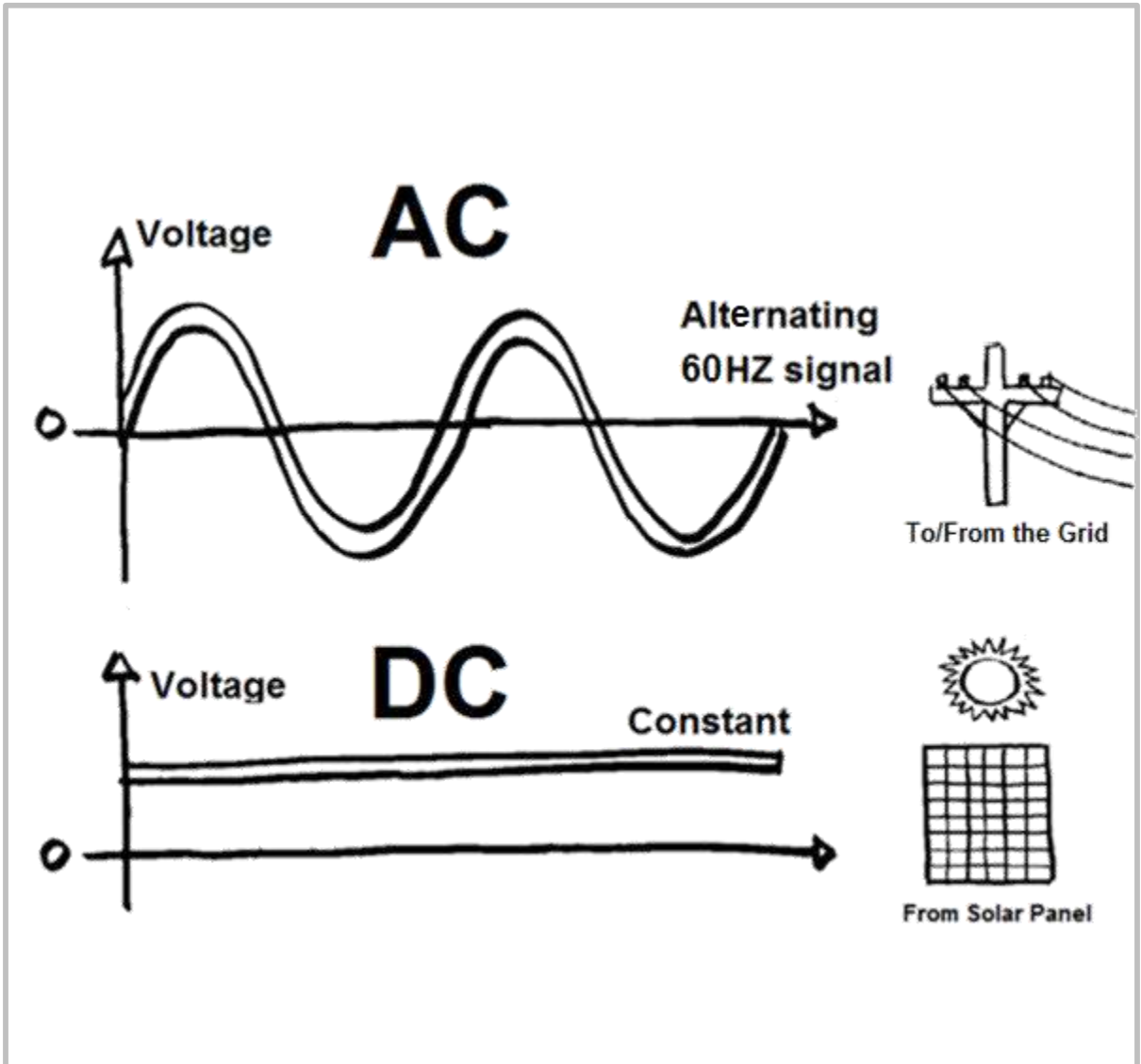

In electrical terms, electrical power is the rate of flow of electrical energy in a unit time. Electrical power can be also classified as AC Power or DC Power. Alternating Current (AC) as pure sign wave is usually generated by the utility grid for our homes electric consumptions and the energy generated by the solar panels or batteries is Direct Current (DC).

SOLAR CELLS

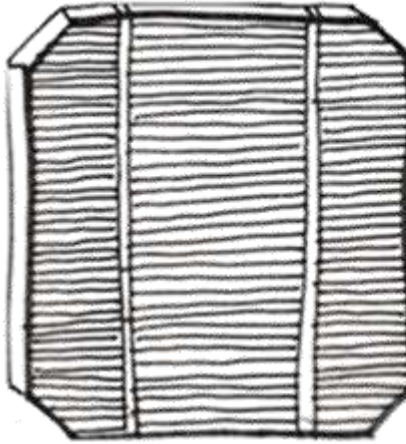

Mono-Crystalline

MONO



Poly-Crystalline

POLY
or
MULTI

Modern solar cells come in different colors, shapes and sizes. The most popular cell "Mono" has a uniform darker blue or black color and is marked with cutting edges. It is made from slicing one pure silicon cell while the "Poly or Multi" cell has different light colors, resembling a camouflage of melting different silicones together as one cell. The mono cell is more efficient and lasts longer than the poly with space efficiency from 13-15%.

FRONT PANEL

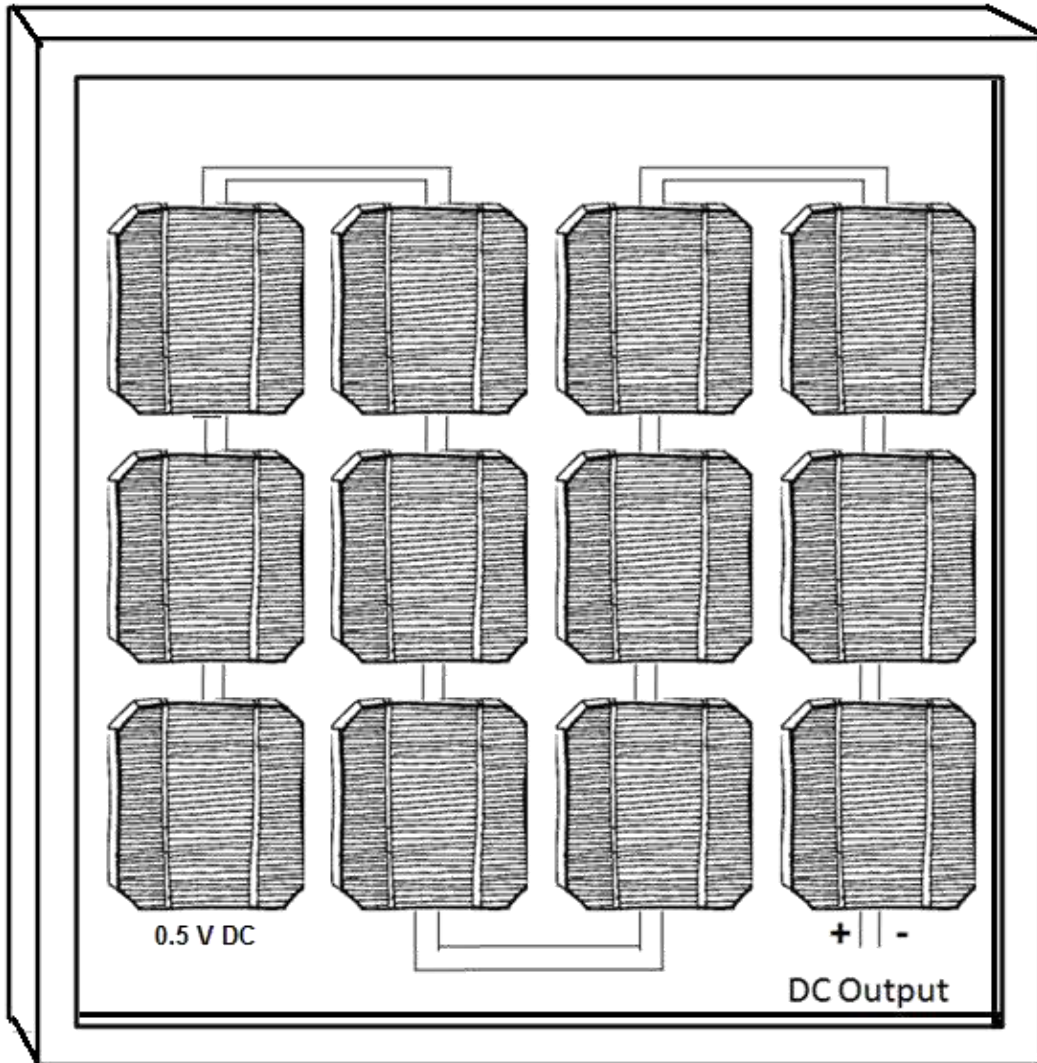

In front of the panel, we can see the solar cells. Each cell can generate a small DC voltage (0.5V). When they are connected together in serial, the maximum voltage output is equivalent to the sum of all cells outputs, just like the batteries. For example: For 12 cells x 0.5V generated from each cell makes a total voltage of 6 DC Volts.

BACK PANEL

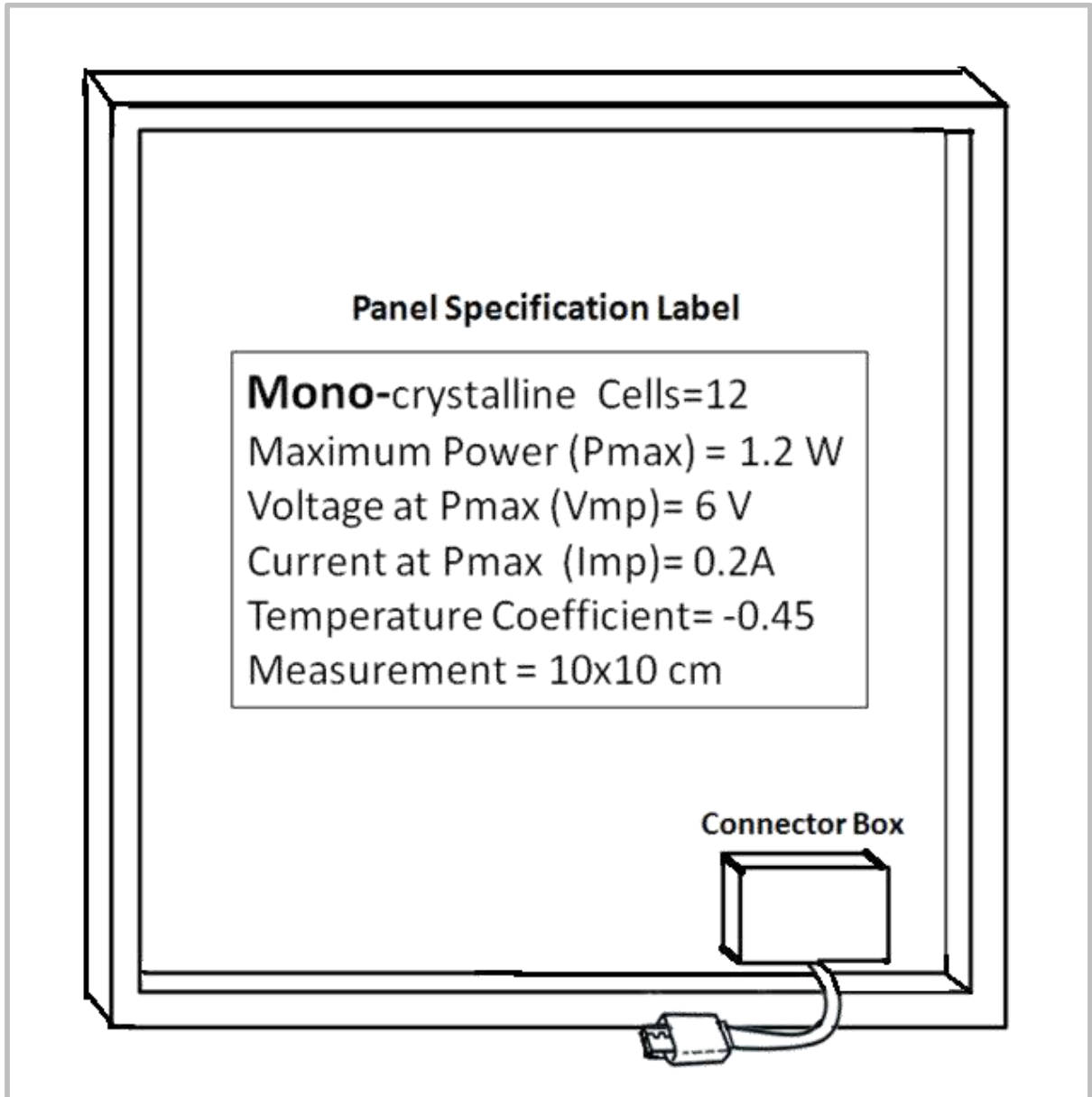

At the back of solar panels, you will see the supplier specification. Such as size of panel, type of cells, numbers of cells, max. generated power, max. output voltage, max. current and the recommended operating temperature. It also has a connector box and short cable for connecting external devices.

PANEL CONSTRUCTION

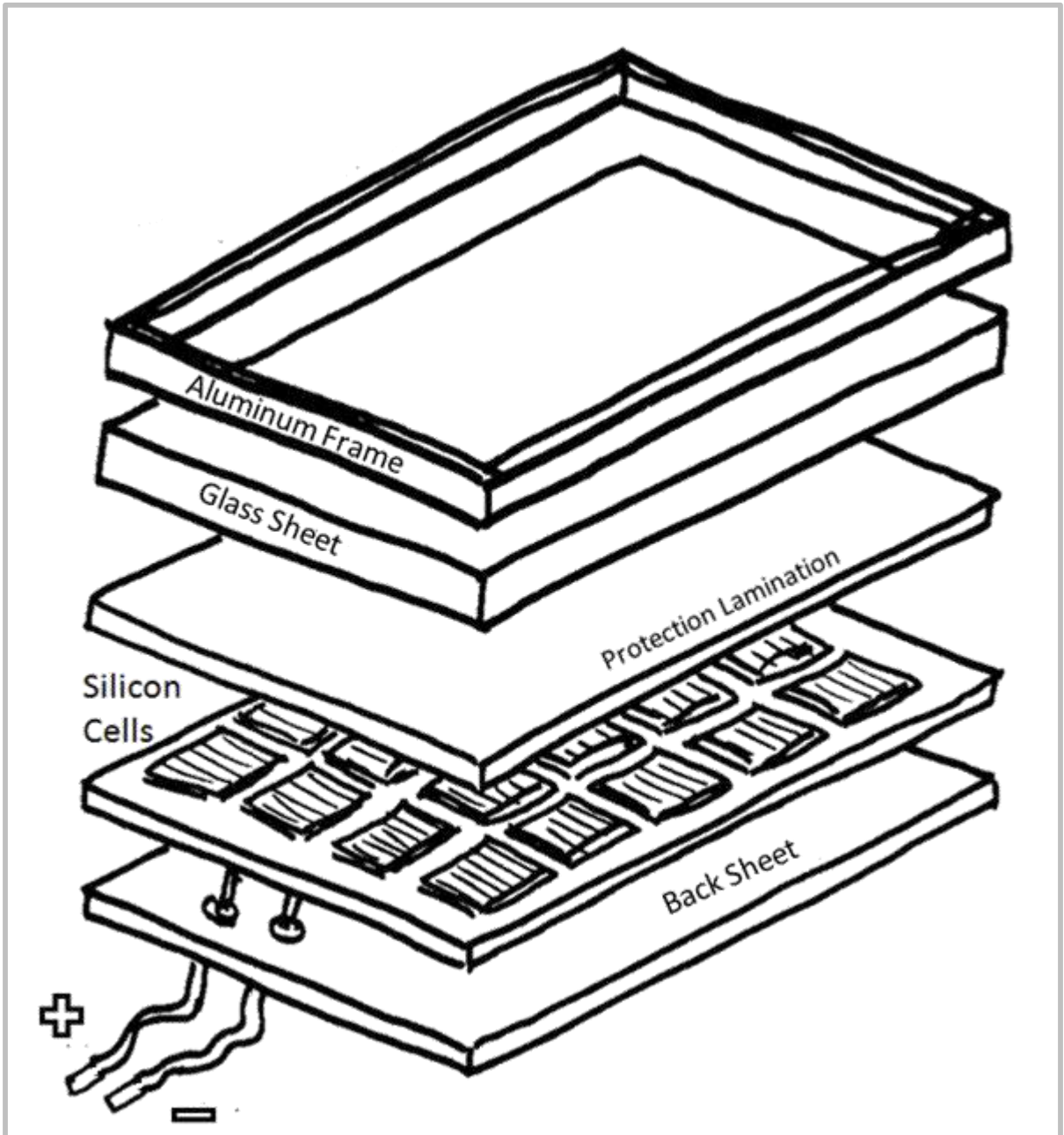

Solar panels are carefully constructed in the factory to protect the cells with glass and lamination to let the sunrays in and to keep out moisture and dirt away from the silicon cells.

SOLAR ENERGY SYSTEM

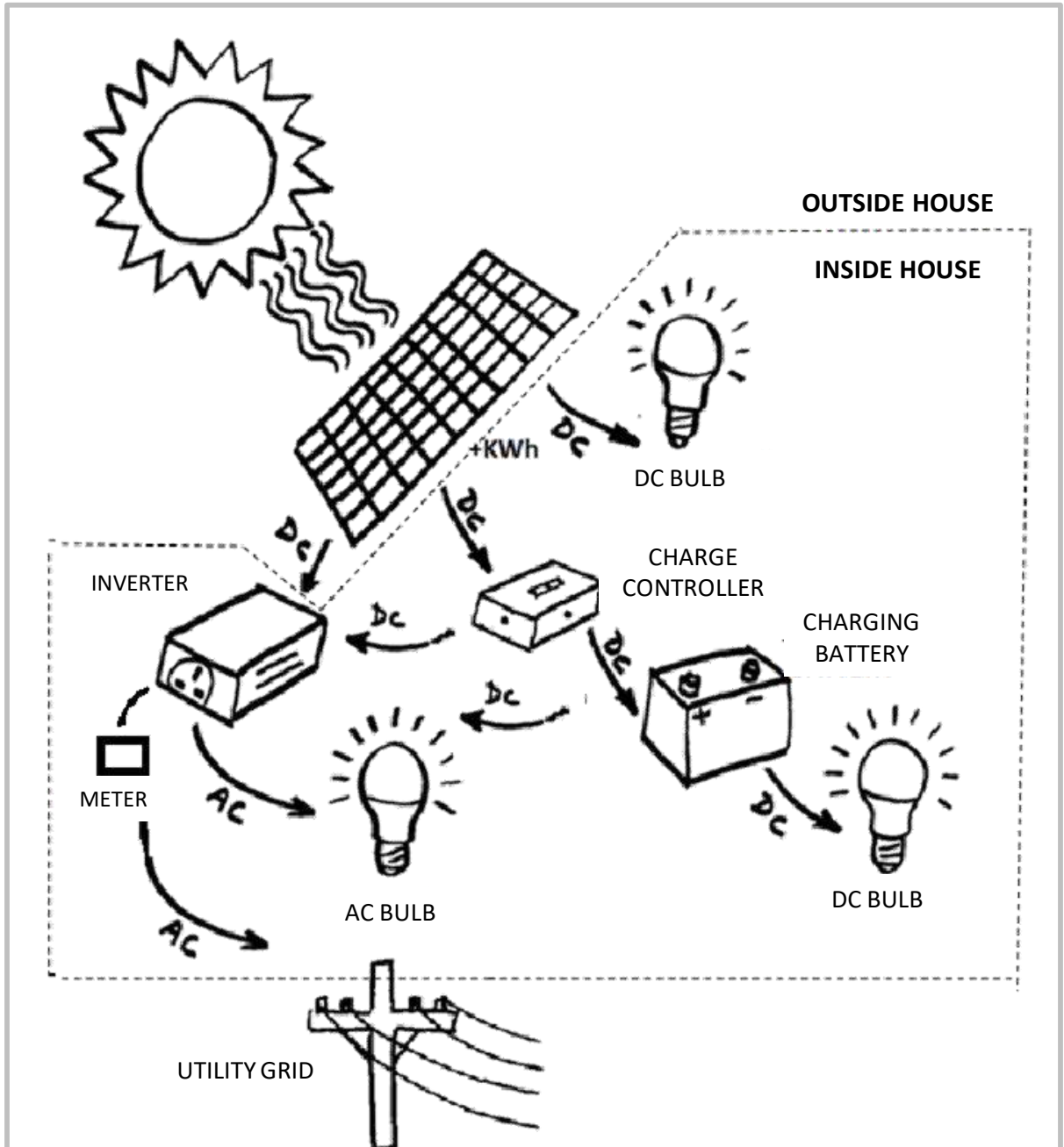

A simple solar energy system is made up from solar panels, an inverter to convert DC to AC power, charge controller and charging battery.

BATTERY, CONTROLLER & INVERTER

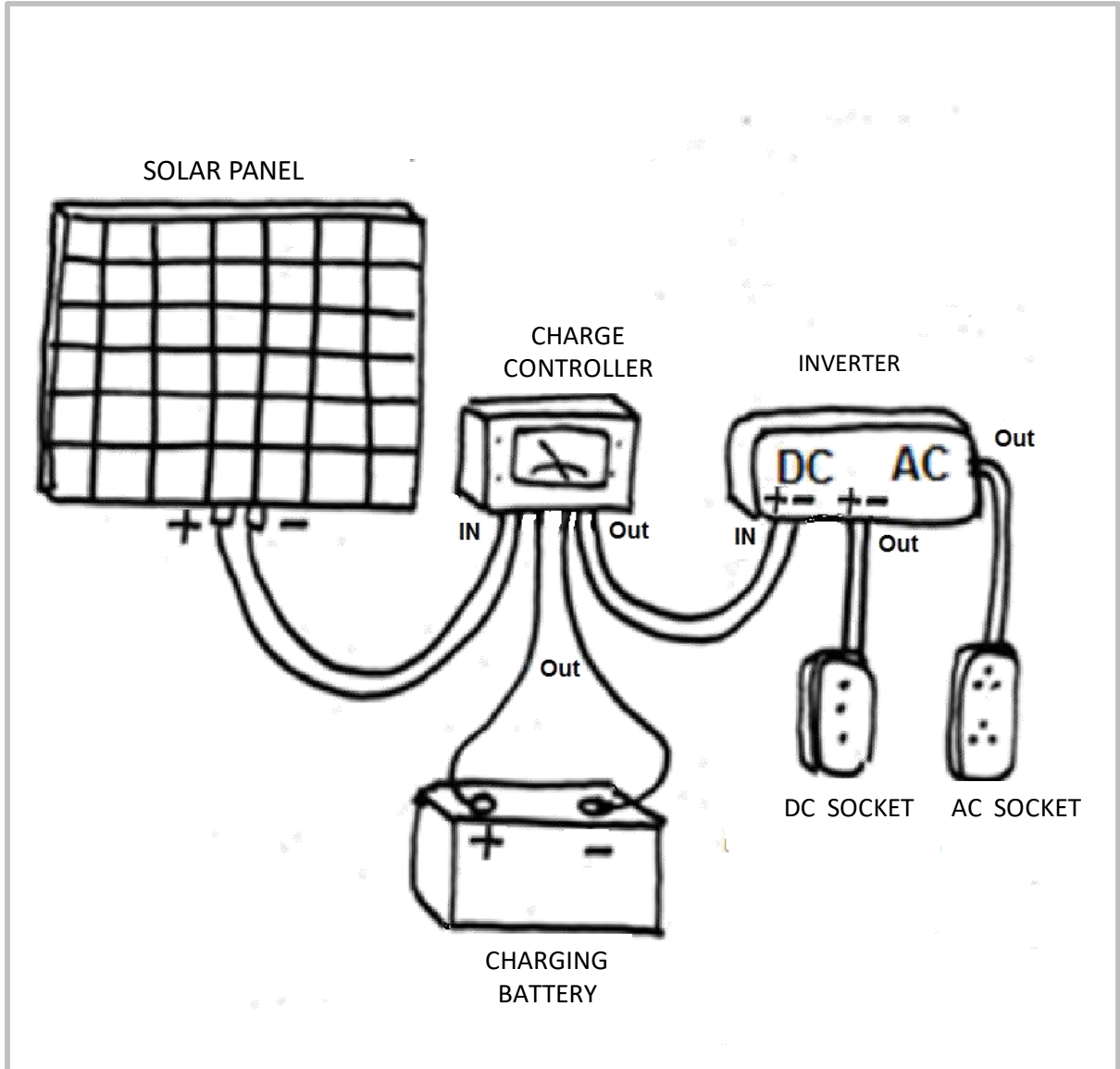

The main elements of the solar energy system can be identified as the battery which can save the energy for use when the sun disappears and the converter can convert from DC power to AC and the charge controller is to protect the battery from overcharging and getting damaged.

FINANCIAL BENEFITS

$KWh = KW \text{ generated} \times \text{Number of hours}$

$\text{Profit} = KWh \times \text{Tariffs}$

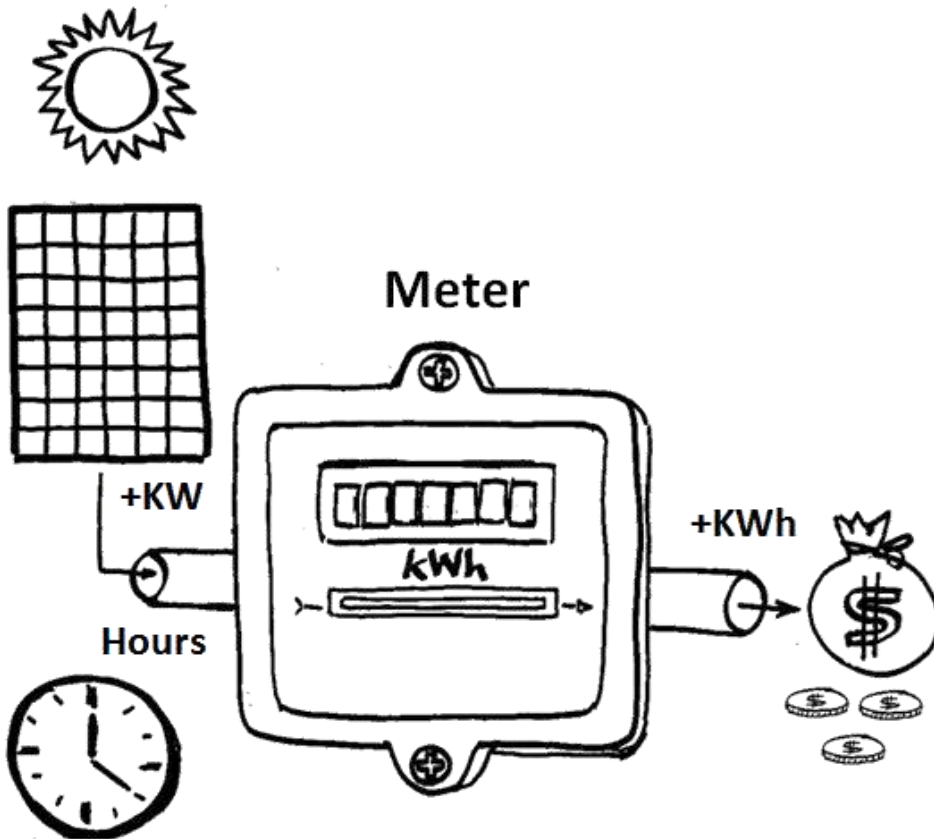

Besides its clean energy benefits, there are financial benefits as well. House owners can install solar panels on top of their homes to generate electricity that can feedback power to the utility grid. Hence, can make a profit from electricity generation whenever the sun shines on the solar panels. The profit rate depends on the solar energy generated per hour and the tariffs by the electricity provider.

NET METERING

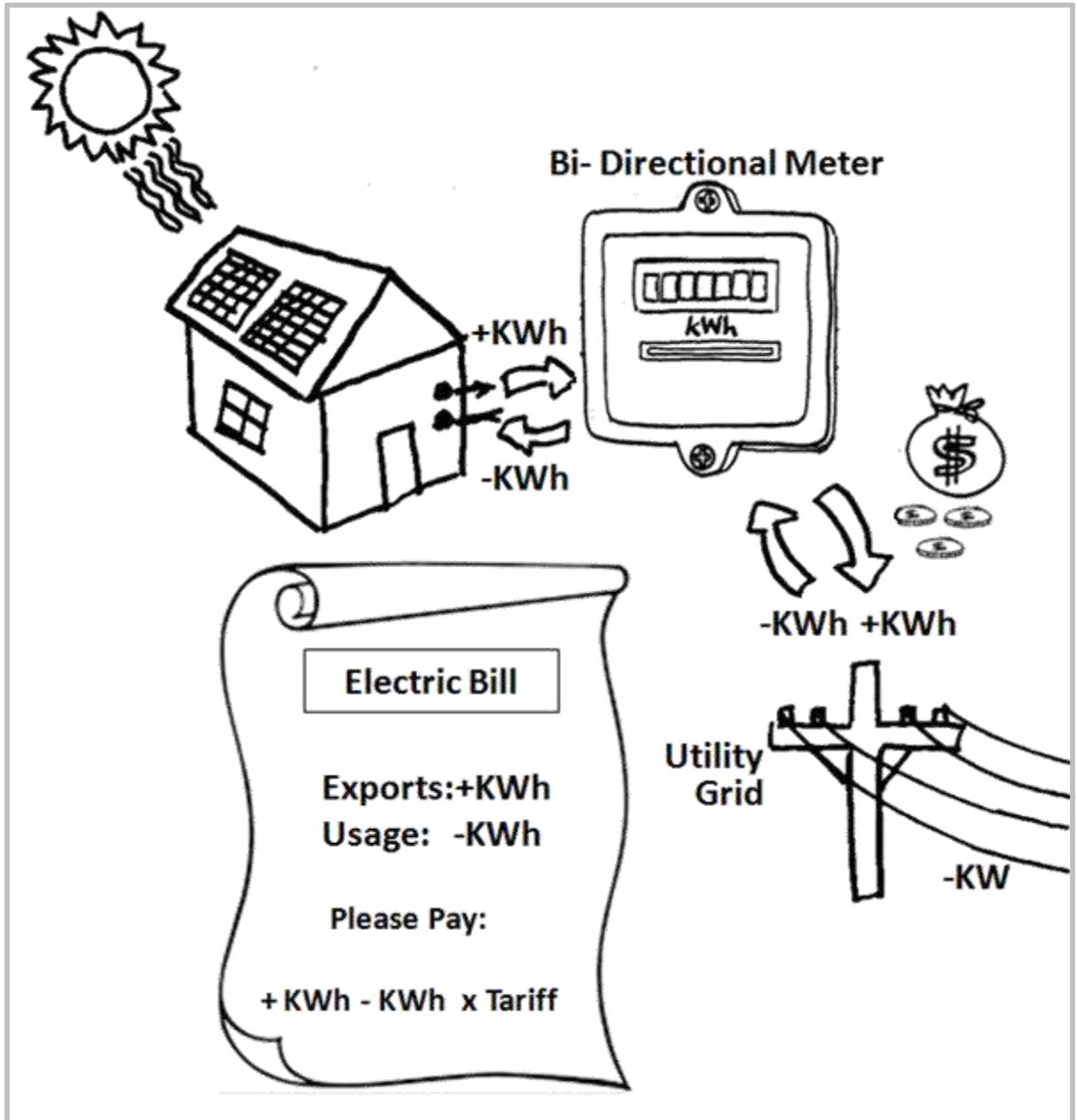

The Net Metering is a billing system that credits solar energy system owners for the electricity they add to the utility grid. The two way or bi-directional net meter will record how much energy is debited and credited in the monthly billing system.

SOLAR TRACKING

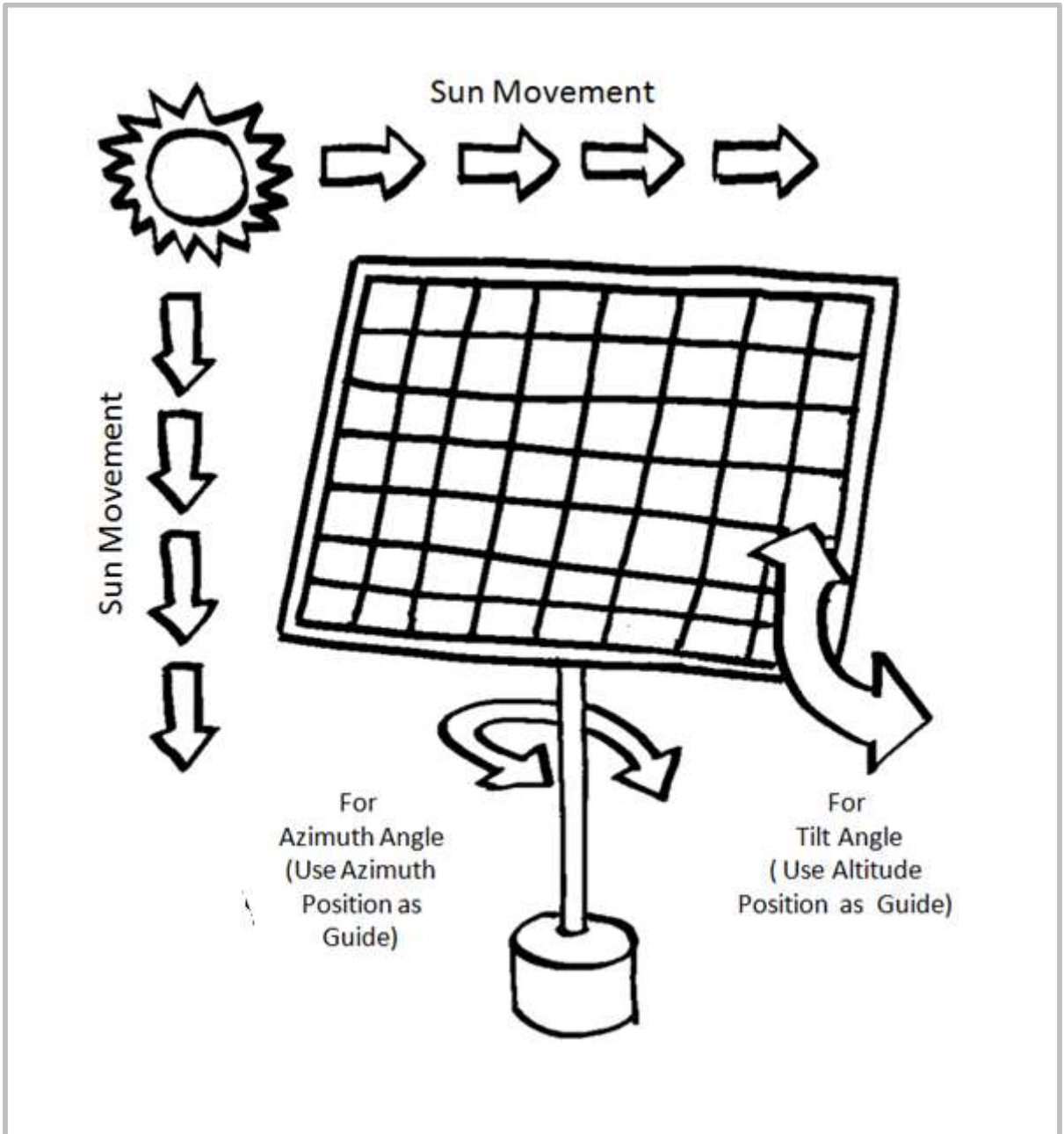

The sun position is changing all the time. Solar panels can achieve up to 40% extra power when tracking the sun's different movements throughout the year.

AUTO TRACKING

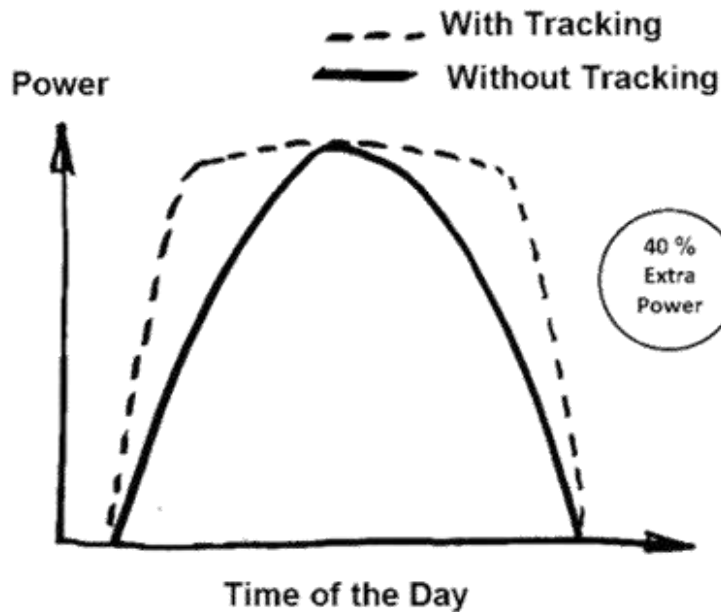
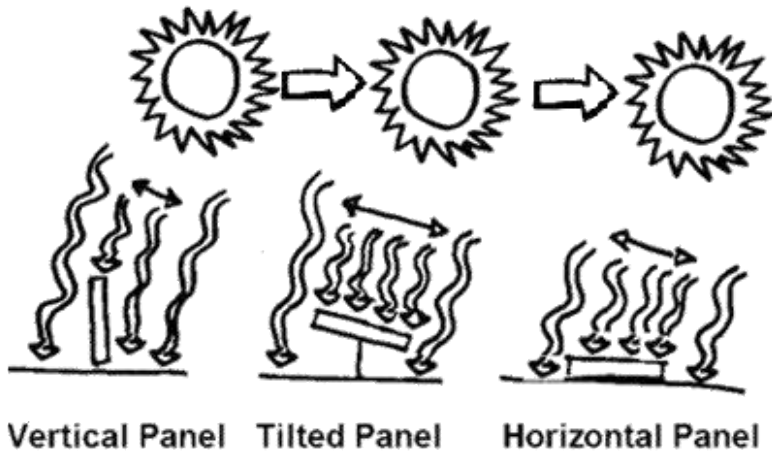

A solar tracking system will automatically try to capture as much energy from the sun during the day when compared to the fixed panel system. But unfortunately, the auto tracking is expensive to buy and can be costly for home users.

FIXED TILT ANGLE

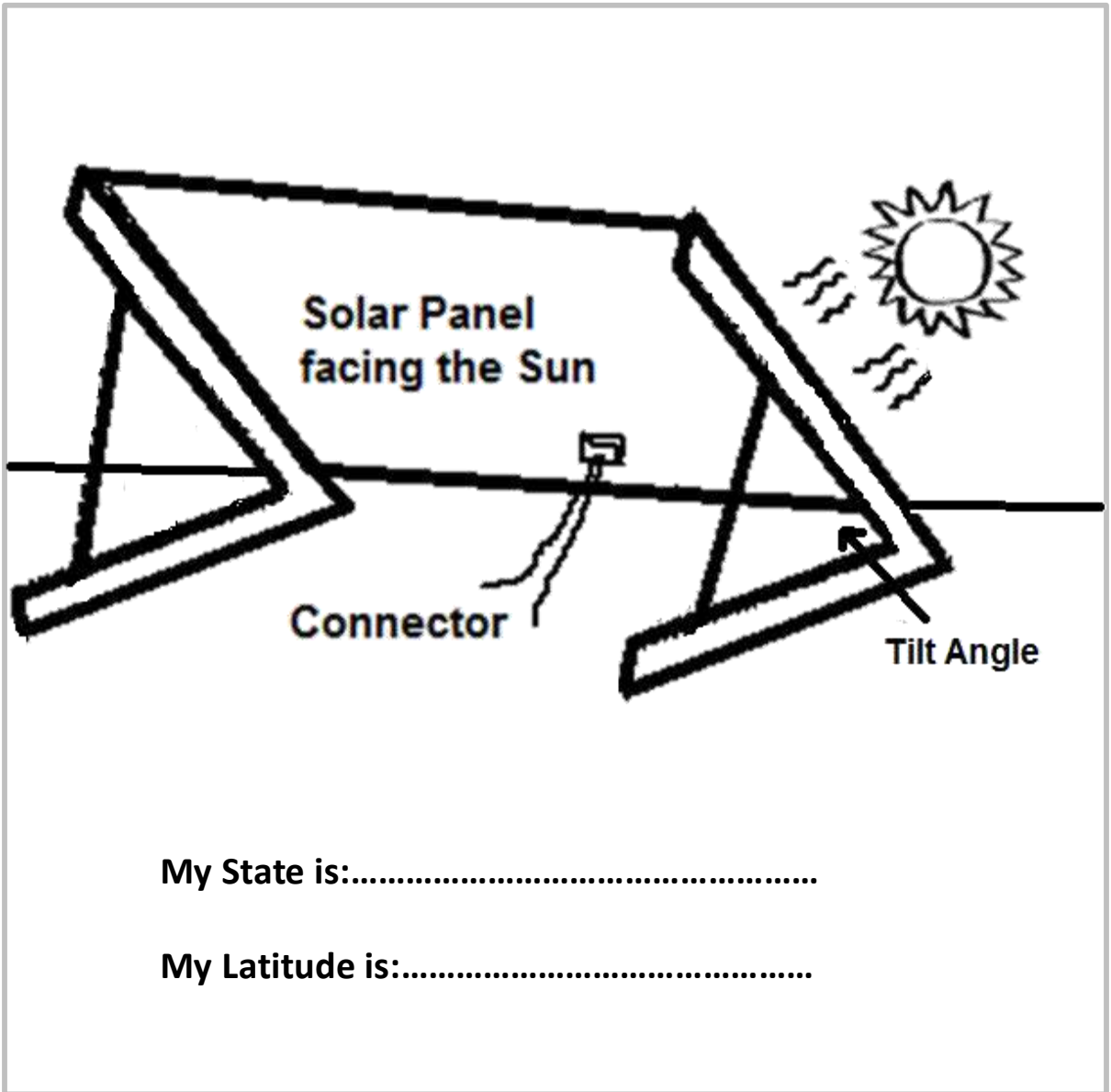

With fixed angles, you can never be accurate with your setup because the sun moves throughout the year. The best practical method, if you don't want to bother with adjusting your panels all year round, is to set them at a tilt angle that is equal to your position or your state latitude.

SHADES ON PANELS

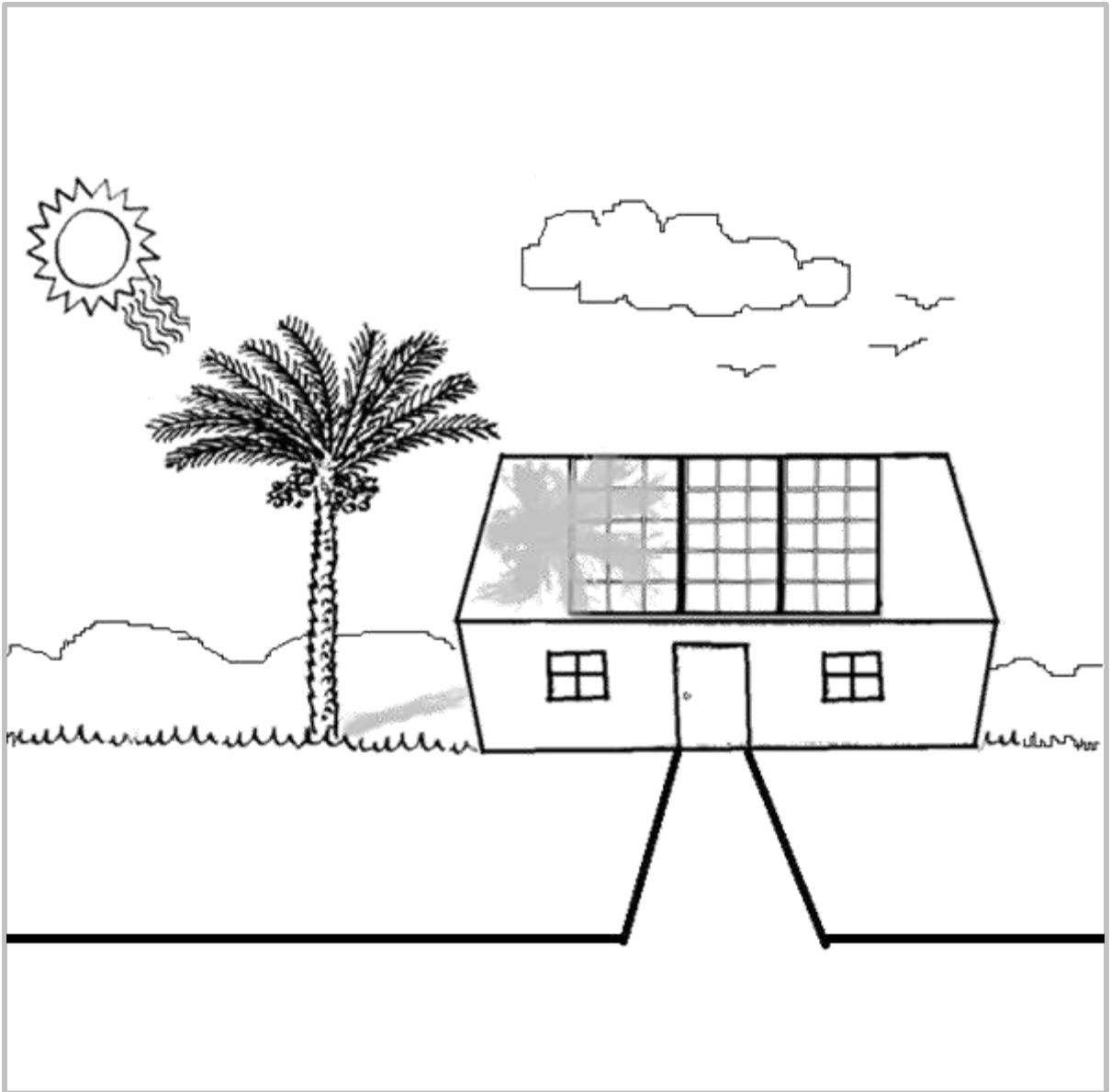

Nearby buildings and trees will block the sun rays on the cells. Therefore, the output performance of solar panels will be low because every cell contributes to the total power output. Hence, avoid shades for maximum solar energy performance.

HEAT ON PANELS

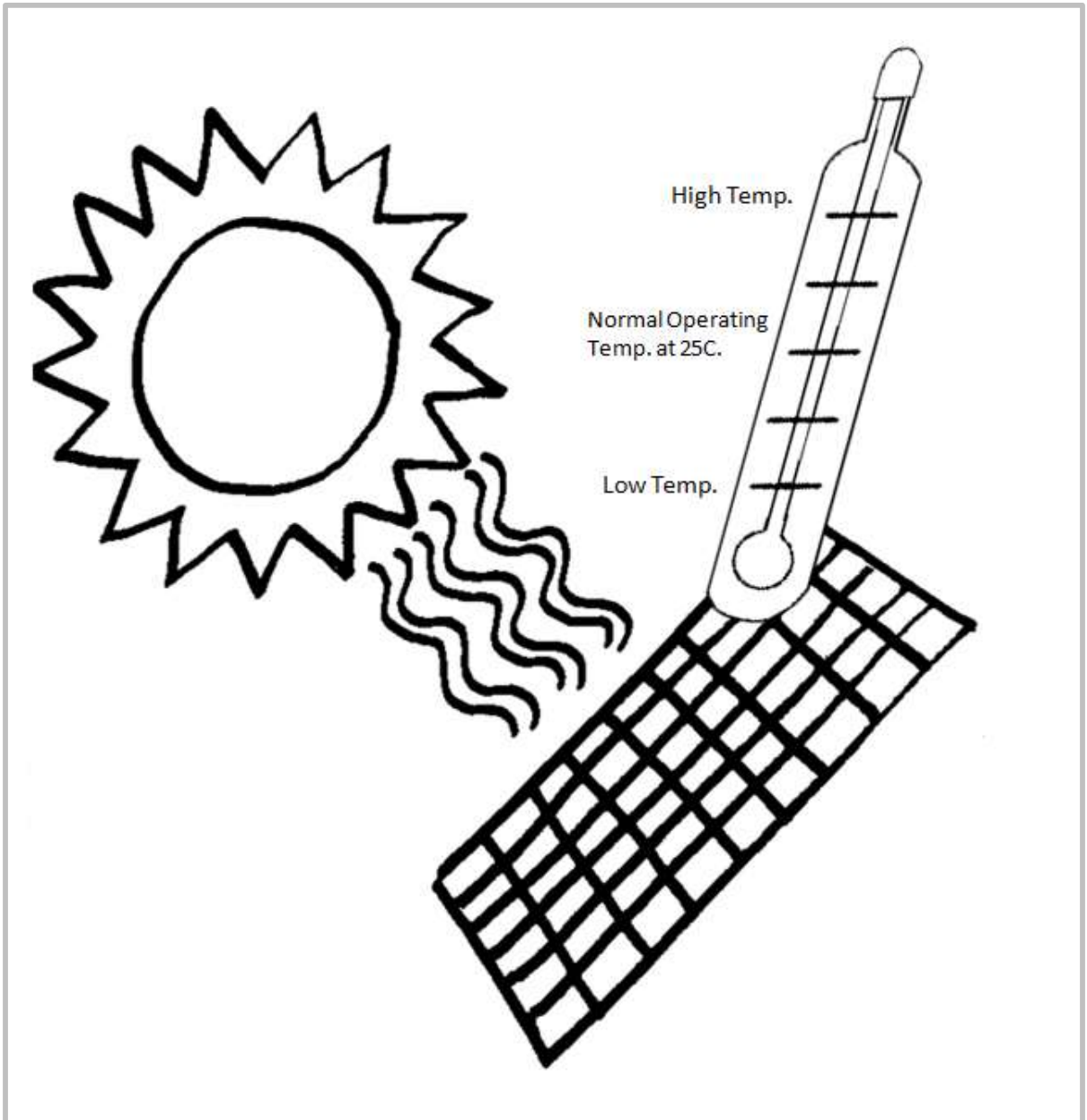

Solar panels power output efficiency can be affected by high atmospheric temperatures. Therefore, investing on panels with low-temperature coefficient is advised.

DIRT ON PANELS



Solar panels will need cleaning all the time by water and soap to get rid of dust, bird's waste, and tree leaves. Otherwise, solar panels will have poor performance if the cells are covered with dirt which can block the sun rays from reaching them.

POWER GUIDE



LED Bulb
3 Watts



Smartphone
10 Watts



Fan
20 Watts



Radio
50 Watts



Laptop
100 Watts



Television
200 Watts

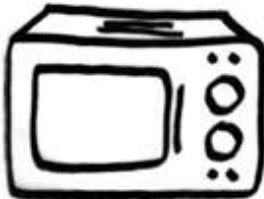

Micro-wave
600 Watts

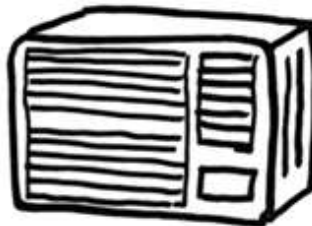

*Air-conditioner (1/2 Ton=6000 BTU)
1800 Watts



Iron
1300 Watts

* Convert BTU (British Thermal Unit) to Watts by formula = $BTU/3.41$

Each household device has different power consumption. Therefore, the solar panels total power output needs to be higher than those devices' total power consumptions to ensure proper power feed from panels.

SOLAR PANELS (1W)

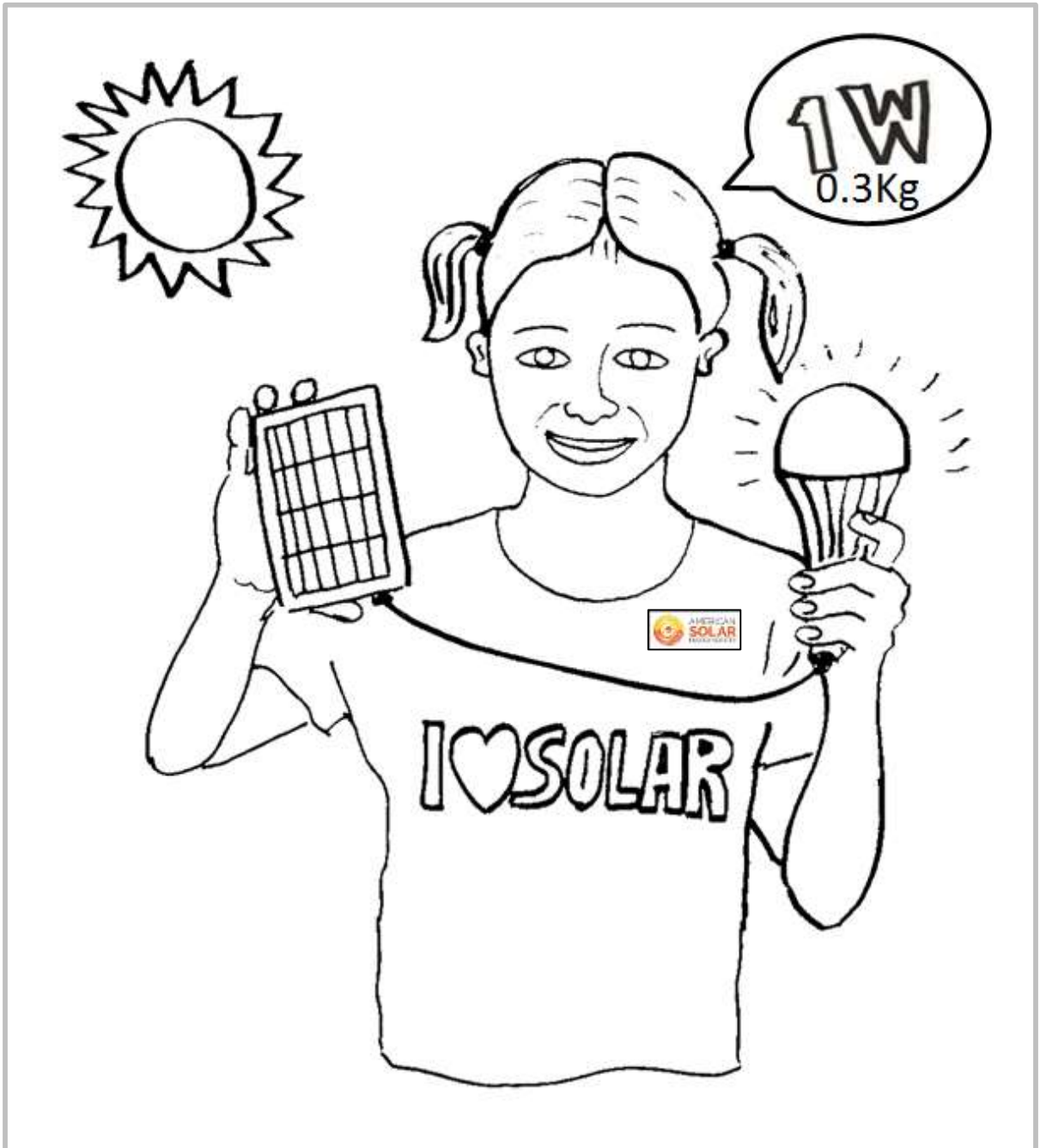

Tiny solar panels are safe to handle. They can provide 6 volts, 1 watt energy which is enough to operate low power rated devices, such as 1 watt LED bulb.

SOLAR PANELS (10W)

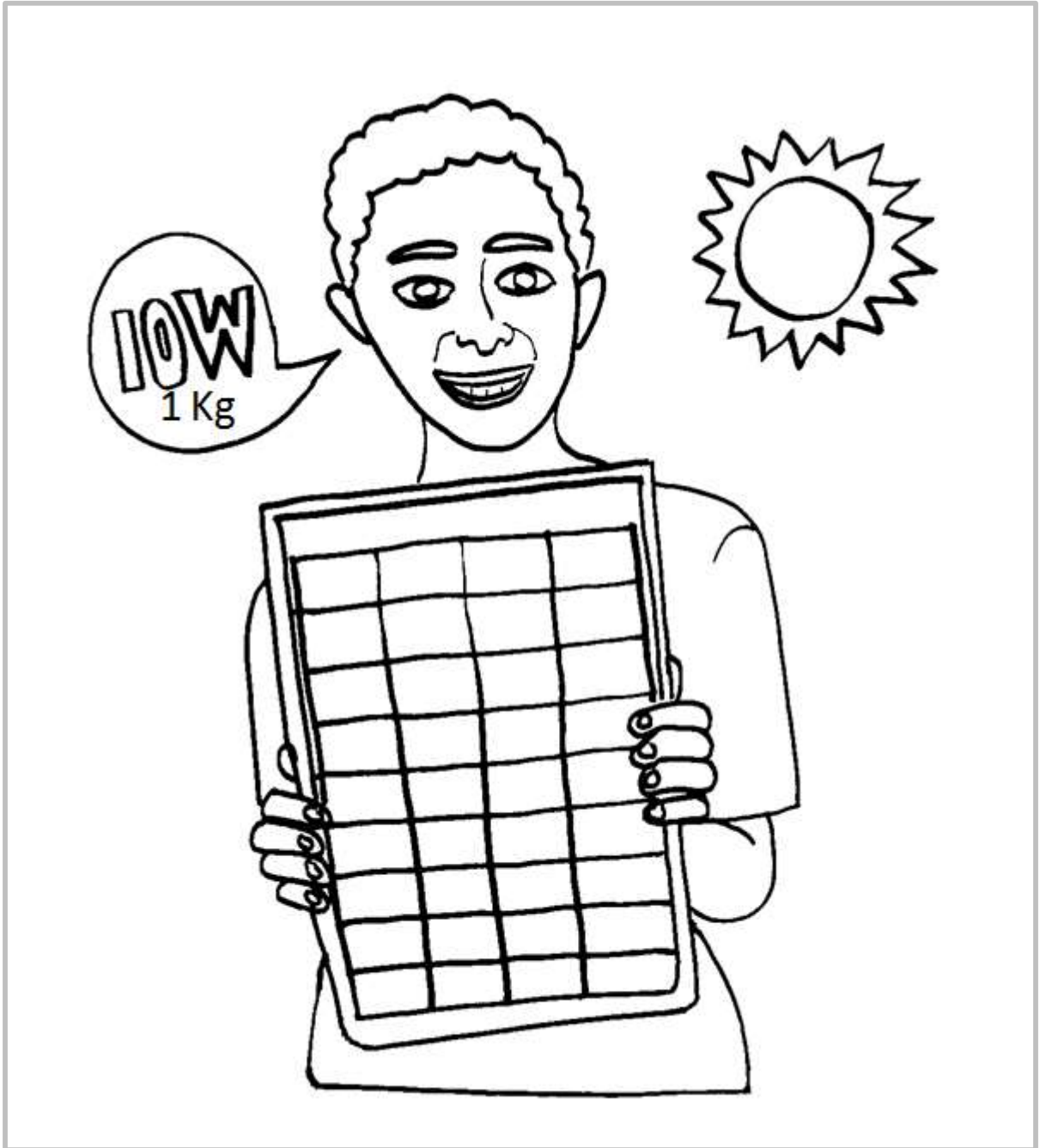

Solar panels are still safe to handle at 10 watts. They can operate 10 watts DC bulbs or number of lower wattage devices.

SOLAR PANELS (100W)

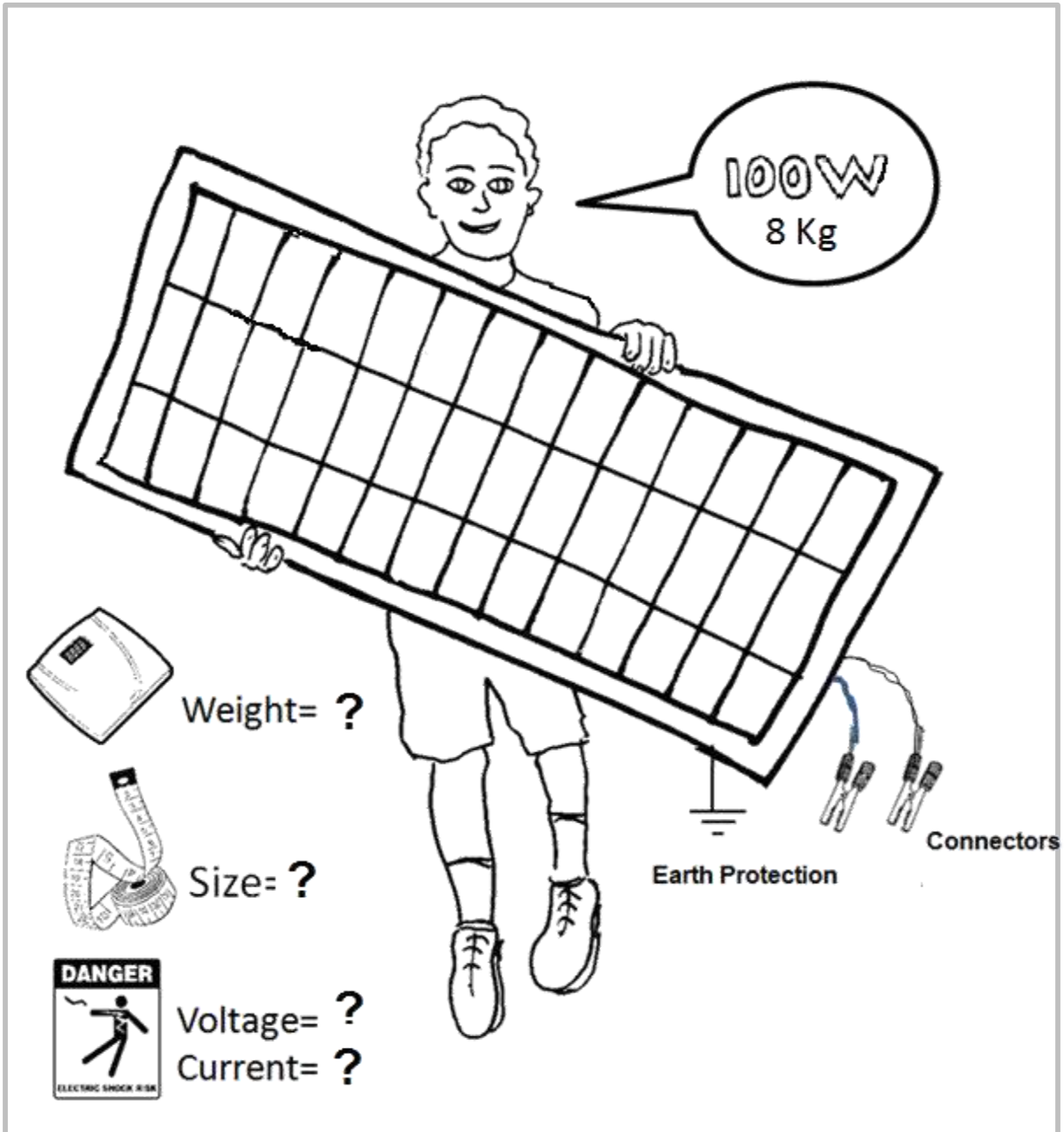

As solar panels get larger in size and heavier in weight with higher power outputs, then some safety issues are important when handling them. So be careful and ask a qualified electrician to assist you.

SOLAR BUS-STOP



Modern bus-stops can be made with roofs from flexible solar panels which are thin, lightweight and can be bent or rolled up as required by the designers. Those flexi type panels can charge mobile phones, operate the station clock, light up route maps and advertisement boards, etc. However, they have lower efficiency than normal panels but their portability makes them suited for artistic and fancy decorations on buildings for better look to the surrounding environment. 30

SOLAR TENT

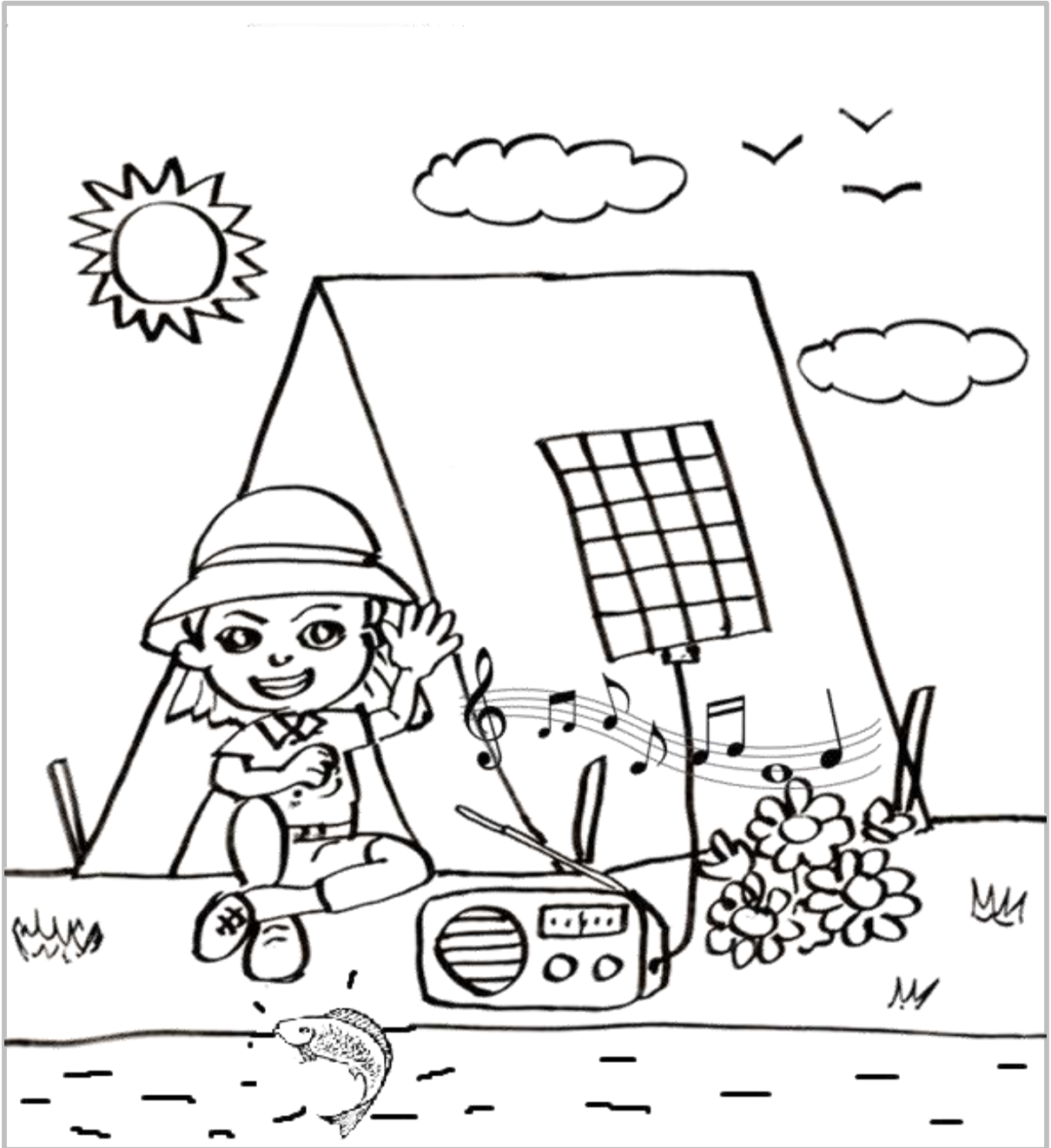

There are other uses of the flexible solar panels. They can be fixed on camping tents to cook food, provide cold and hot water, watch TV or listen to music.

WORKSHEET 1

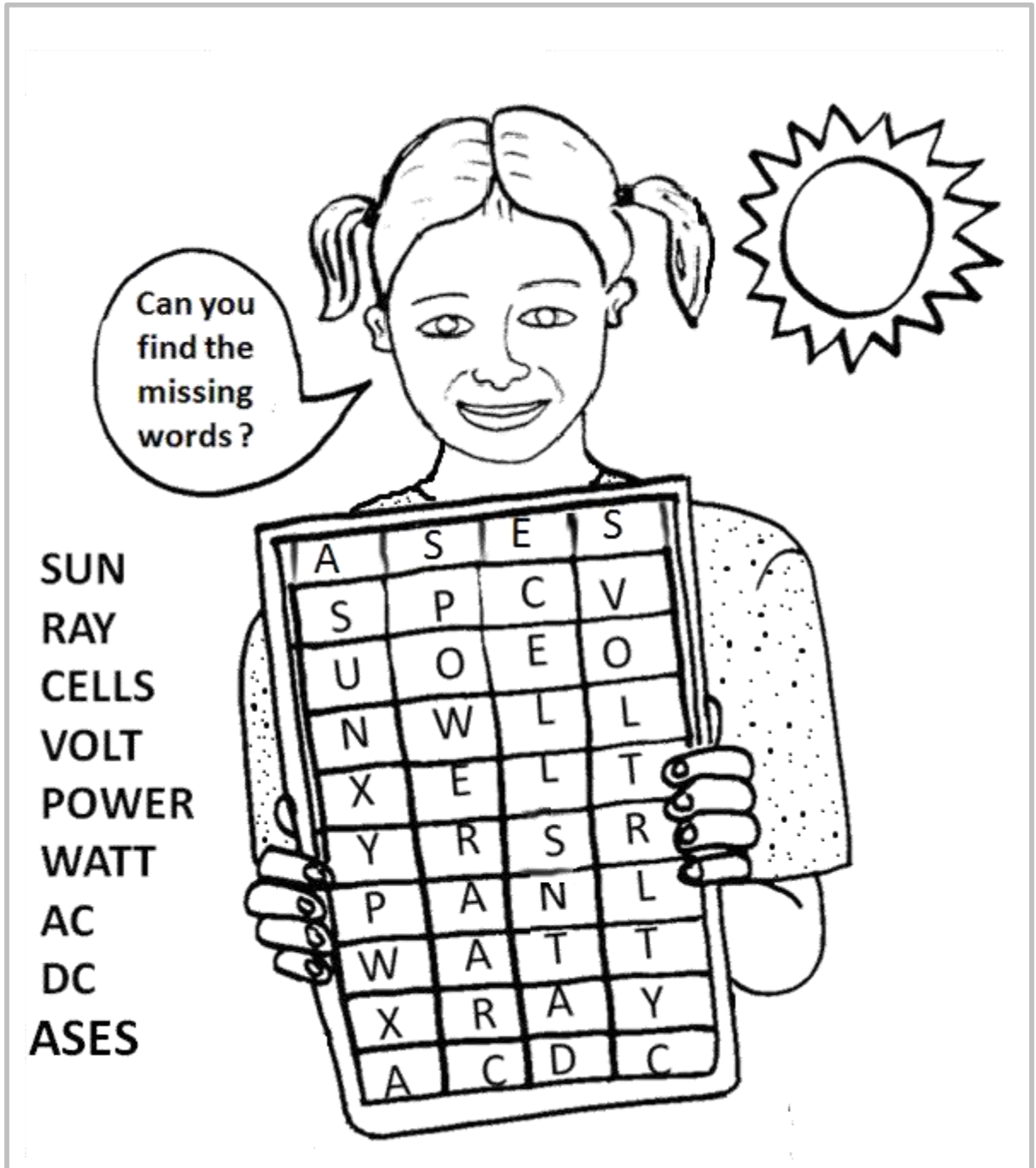

After learning the solar energy keywords, now it's time to answer the worksheets. They will help you to emphasize what was learnt. The first worksheet is for finding the words on the panel.

WORKSHEET 2

Answer correctly by Coloring the True or False boxes with your favorite Color.

1. The Poly type is more efficient than the Mono Type.

2. The Poly type takes less space than the Mono type.

3. The Poly type is more expensive than the Mono type.

4. The Poly type has a darker color than the Mono type.

5. Solar cells produce 0.5-0.6 V AC output.

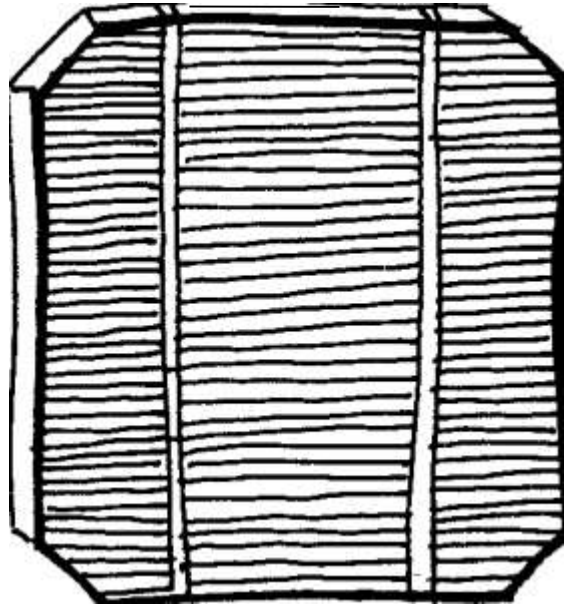

Mono-Crystalline



Poly-Crystalline

WORKSHEET 3

Answer correctly by coloring the True or False boxes with Green Color

1. Shades from Trees are good because they can cool down the Solar Panels.

T
F

2. No need to clean the Panels because sun energy will clean them.

T
F

3. We can mix different types of panels for our solar energy system.

T
F

4. Solar panels can be flexible or folded.

T
F

4. Panels with Mono cells have a better life and space efficiency.

T
F

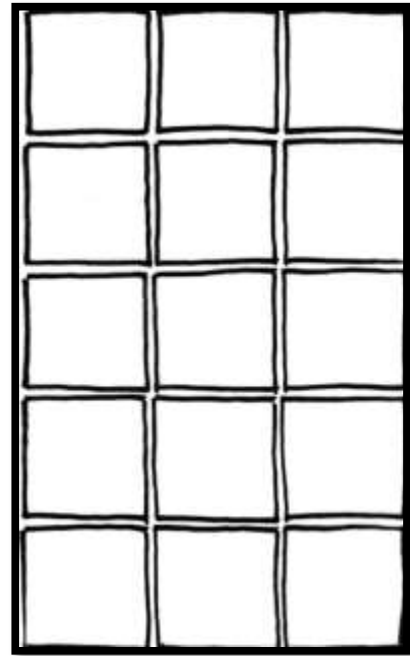

Poly

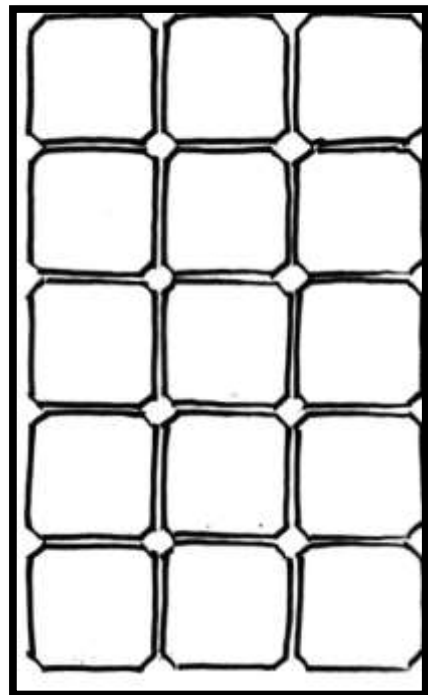

Mono

WORKSHEET 4



LED Bulb
— Watts



Smartphone
— Watts



Fan
— Watts



Radio
— Watts



Laptop
— Watts



Television
— Watts



Micro-wave
— Watts

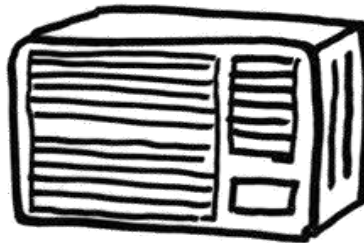

*Air-conditioner (1/2 Ton=6000 BTU)
— Watts



Iron
— Watts

Required Solar Power = Watts?

Can you estimate the power consumption for each device and the total solar power required to operate ALL of them at the same time?

WORKSHEET 5

Solar Panel
6V DC , 100 mA

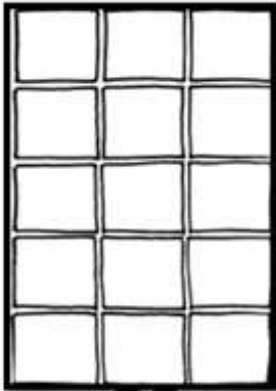

+ 00 -

Solar Panel
6V DC , 100 mA

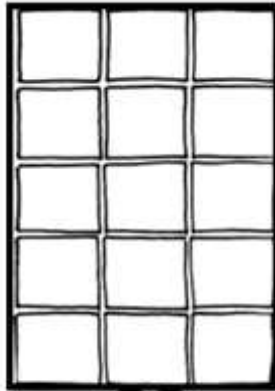

+ 00 -

Solar Panel
6V DC , 100 mA

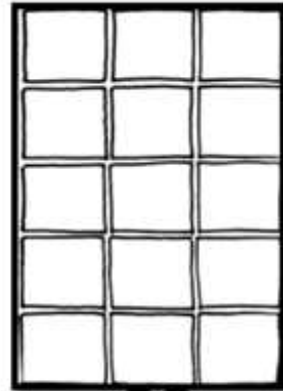

+ 00 -



LED Bulb
18 V DC , 100 mA

Connect the three 6V solar panels to operate the 18 V DC and 100 mA bulb.

WORKSHEET 6

Solar Panel
6V DC , 100 mA

Solar Panel
6V DC , 100 mA

Solar Panel
6V DC , 100 mA

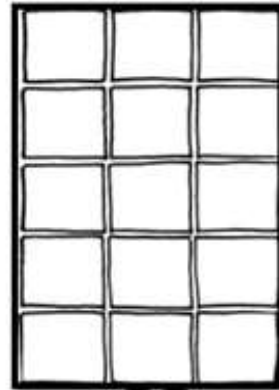
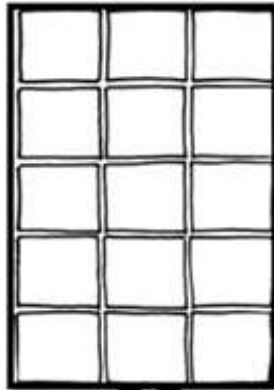
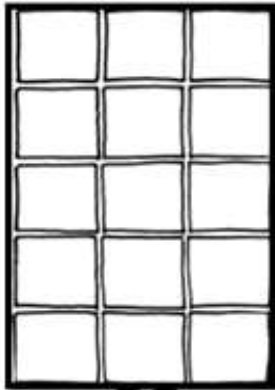

+ □ □ -

+ □ □ -

+ □ □ -



LED Bulb
6 V DC, 300 mA

Connect the three 6V solar panels to operate the 6 V DC and 300 mA bulb.

3D SOLAR HOUSE PROJECT

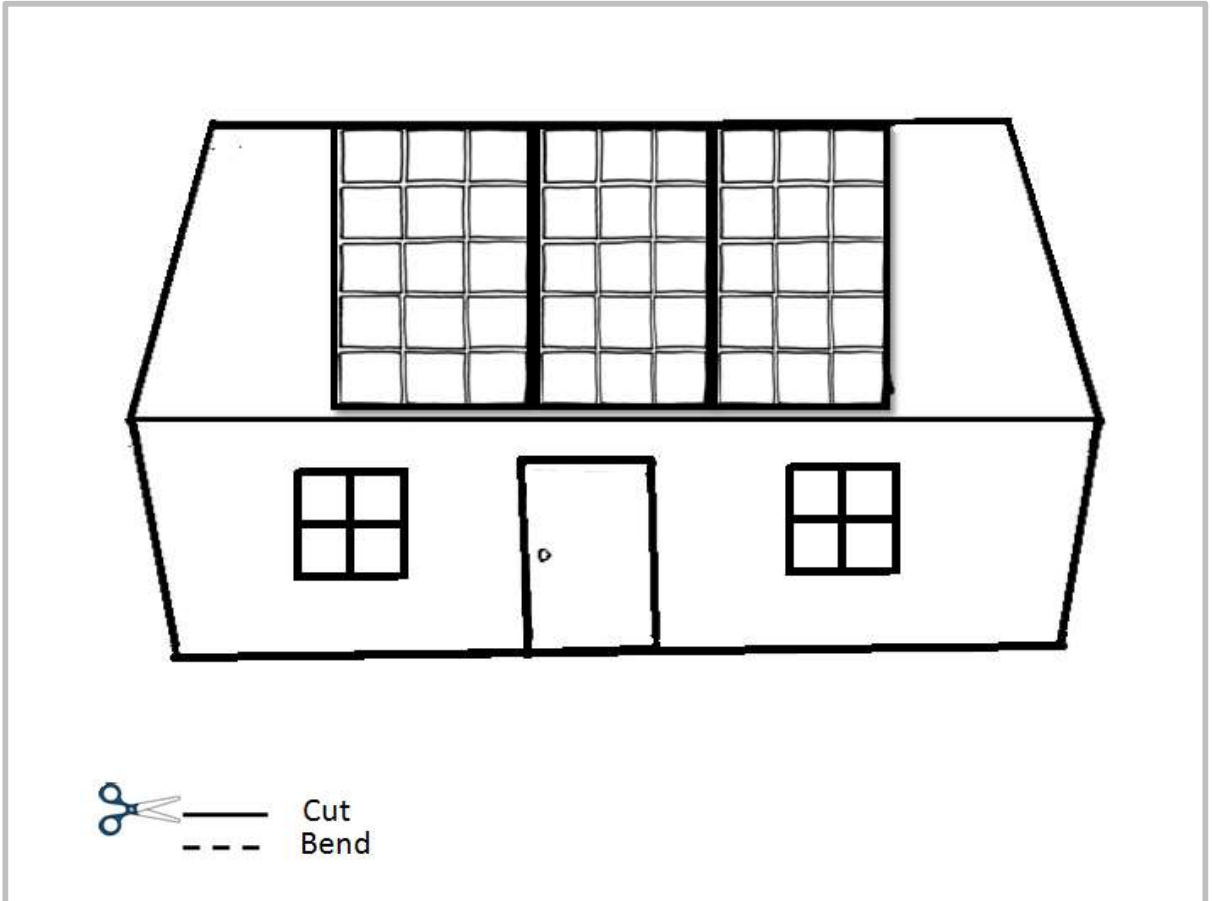

Your task is to build a 3D paper house with a solar energy system inside it.

Instructions:

1. First, paint the sheets inside and outside according to your preferred decoration colors.
2. Ensure the sheets are perfectly aligned on each others before cutting & bending.
3. Cut and bend the sheets according to the lines shown above for cutting and bending.
4. Finally, join the sheets with a fast drying glue.

If you enjoyed this FREE solar energy workbook activities, then please send your work electronically on a PDF file for our experts' review. You could be eligible for a special life-long International Certificate from the USA. Support for certificates administration is also available for schools. For enquiries contact:
email: info@solarenergyworkbook.com

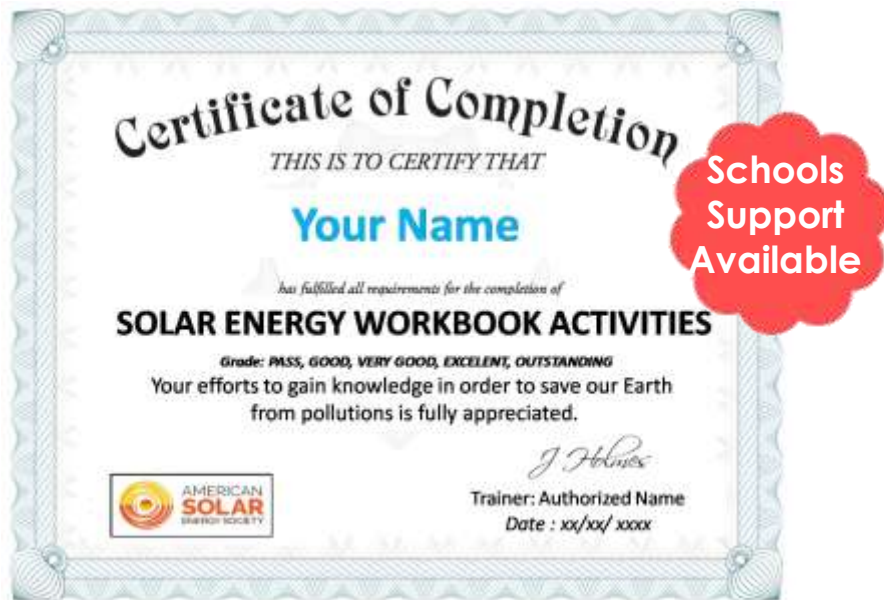

For Enquiries:

www.solarenergyworkbook.com



ISBN: 978-99901-32-50-2
2019/278

American Solar Energy Society

2525 Arapahoe Avenue
Suite E4-253
Boulder, CO 80302
Website: www.ases.org

Copyright ©2020